

ANNUAL REPORT
2011/2012



THE FRAUNHOFER INSTITUTE FOR EXPERIMENTAL SOFTWARE ENGINEERING IESE

Fraunhofer Institute for
Experimental Software
Engineering IESE
Fraunhofer-Platz 1
67663 Kaiserslautern
Germany

Phone +49 631 6800-6000

Fax +49 631 6800-1099

www.iese.fraunhofer.de

Executive Director
Prof. Dr. Dr. h. c.
Dieter Rombach

Scientific Director
Prof. Dr.-Ing.
Peter Liggesmeyer

Software is a part of our lives. Embedded into everyday equipment, into living and working environments or modern means of transportation, countless processors and controllers make our lives simpler, safer, and more pleasant. We help organizations to develop software systems that are reliable in every aspect, and provide empirical proof of the necessary processes, methods, and techniques, emphasizing engineering-style principles such as measurability and transparency.

Fraunhofer IESE in Kaiserslautern is one of the worldwide leading research institutes in the area of software and systems development. A major portion of the products offered by its collaboration partners is defined by software. These products range from automotive and transportation systems via automation and plant engineering, information systems, health care and medical systems to software systems for the public sector. The solutions allow flexible scaling. This makes the institute a competent technology partner for organizations of any size - from small companies to major corporations.

Under the leadership of Prof. Dieter Rombach and Prof. Peter Liggesmeyer, Fraunhofer IESE has spent the last fifteen years making major contributions to strengthening the emerging IT hub Kaiserslautern. In the Fraunhofer Information and Communication Technology Group, it is cooperating with other Fraunhofer institutes on developing trend-setting key technologies for the future.

Fraunhofer IESE is one of 60 institutes of the Fraunhofer-Gesellschaft. Together they have a major impact on shaping applied research in Europe and contribute to Germany's competitiveness in international markets.

© 2012 Fraunhofer IESE

Editorial Notes

Editorial Board:

Dipl.-Dolmetscherin Sonnhild Namingha
(Project Management, Editor)

Translation:

Dipl.-Dolm. Sonnhild Namingha

Layout and Setting:

Dipl.-Betriebswirt (BA) Stephan Thiel

CD-ROM Production:

digiCon AG, Kornwestheim

Photographs:

Fraunhofer IESE

Fraunhofer PR-Netzwerk

iStockphoto.com

John Deere (p. 69/87)

Eckert & Ziegler (p. 71)

DESY (p. 91)

Hans-Joachim Rickel,

Federal Ministry of the Interior (p. 97)

CoBRA®, CROCODILE®, FAME®, GQM+Strategies®, NiXE®,
OSR®, PuLSE® and SPEARMINT® are registered trademarks of
Fraunhofer-Gesellschaft.

All other products and tradenames may be registered by their
respective owners. A lack of such indication does not imply
that a particular name is free of third-party rights.



EDITORIAL

INNOVATION AND COMPETITIVENESS THROUGH MOBILE SERVICES

Dear reader,

In all branches of industry, innovations are increasingly driven by software. If you want to stay ahead of your competitors, you will need innovative software and the leading software development expertise available in your domain. Dependable software requires professional development processes. Fraunhofer IESE is a competent and reliable partner for companies from all sectors of industry regarding the subject of "Software Engineering". We offer highly innovative methods and tools for the software development of embedded systems and information systems as well as process know-how for the successful introduction of such methods and tools.

Building on our competencies in the area of cyber-physical systems, we increasingly directed our attention to the use of mobile end devices for product-oriented services in the past year. We are helping manufacturers of agricultural machinery to test the use of smartphones and tablets to support agricultural workflows and to evaluate their added value. Mobile end devices are also used to support workflows in numerous other domains, e.g., in health care to facilitate communication between doctors, nurses, and patients; in production to use situation-related information for maintenance; or among financial service provider to provide support for their sales representatives on the road. Software engineering challenges include how to design suitable user interfaces and how to ensure the necessary data security.

In 2011, we drastically increased our preliminary research on the topic of "mobile end devices" in the Software-Cluster "Software Innovations for the Digital Enterprise" (for information systems). Collaboration in this project is open to additional companies. In cooperation with the European Technology Innovation Center of the agricultural machinery manufacturer John Deere in Kaiserslautern, first applications are currently being tested in practice.

We have established a task force that is committed to merging empirical evidence about our core competencies and complementing these wherever necessary. This will help us to adapt our offers even better to company-specific requirements and will allow us to provide ROI estimates.

There is much that remains to do. The rapid technological progress keeps presenting us with new challenges that we are eager to accept. We have many ideas for new projects with our collaboration partners and those wanting to cooperate with us in the future. IESE enjoys global visibility. This is reflected in the rising numbers of international collaborations with partners from science and industry. In the USA, Australia, and Brazil, we have already founded centers. You, too, can become a partner of IESE! Make use of our competence and benefit from our international network. We will support you on your way towards more innovation and competitiveness through dependable software!

We hope you find this report both informative and inspiring –



Prof. Dr. Dieter Rombach



Prof. Dr. Peter Liggesmeyer

Dieter Rombach

Dieter Rombach

P. Liggesmeyer

Peter Liggesmeyer

CONTENT

	PROFILE OF FRAUNHOFER IESE	9
	Highlight in 2011	10
	Outlook on 2012	14
	The Fraunhofer-Gesellschaft	20
	Fraunhofer IESE and its network partners	22
	IESE in Fraunhofer Groups and Alliances	26
	Organizational Structure	34
	The Advisory Board	36
	Personnel and Budget	37
	BUSINESS AREAS	39
	Automotive and Transportation Systems	40
	Automation and Plant Engineering	42
	Medical Devices	44
	Information Systems	46
	eGovernment	48
	Health Care	50
	DEPARTMENTS	53
	Division Embedded Systems	55
	Division Process Management	59
	Division Information Systems	63
	PROJECTS	67
	JOHN DEERE: Operator in the Loop	68
	ECKERT & ZIEGLER: Future Trends for Safety and Usability in Radiation Therapy	70
	KSB: Establishment of a Future-Proof and Sustainable Software Architecture	72
	SPES 2020 – Functional Safety in the Model-Based Development of Embedded Systems	74
	ARAMIS – Automotive, Railway and Avionics Multicore Systems	76
	DEviSE – Dynamic Identification, Extraction and Reuse of Components in Distributed Software Development	78
	MUREX: Sustaining Success through Business Alignment, Goal-Oriented Measurement, and Best Practice-Based Software Process Improvement	80
	ZLB – Central State-Wide Treatment Capacity Indicator in Rhineland-Palatinate	82
	MULTI – Multi-Touch Interaction for Smart Homes, Energy Management und (Virtual) Museums	84
	JOHN DEERE: Design and Prototype Implementation of a Mobile Task Management Solution	86
	ACCENTURE CAS: Methodological Support for the Architecture Definition of the New Mobile Platform	88
	DESY: Business-Process-Oriented IT Solutions at Deutsches Elektronen-Synchrotron	90

INSIDERS TECHNOLOGIES: Positive User Experience – Interaction Design	92
automotiveHMI – Optimized HMI Development in the Automotive Industry	94
P23R Prozess-Daten-Beschleuniger: Simple, Safe and Efficient Fulfillment of Information Obligations	96
ATTRACT – Security for Distributed Data	98
SOFTWARE CLUSTER: Enforcement of Security Policies across Corporate Boundaries	100
FIBUNET: Keeping the Figures under Control through Continuous Modernization	102

INTERNATIONAL ACTIVITIES

Fraunhofer Center for Experimental Software Engineering, Maryland (CESE)	107
Fraunhofer Project Center for Transport and Logistics in Australia	116
Fraunhofer Project Center on Software and Systems Engineering in Brazil	118
NUTES – Brazil’s Crash Test for Software in Medical Devices	120
Business Alignment with GQM+Strategies® – Headed for Success with the Right Software and Information Strategy	122
MUNDUS – Multimodal Neuroprosthesis for Daily Upper Limb Support	124

CONTACT

How to find us	128
Fraunhofer IESE Contact Persons	132
Information Service	135

APPENDIX

Network in Science and Industry	138
Professional Contributions	144
Scientific Contributions	155
Awards	165

105

127

137



PROFILE OF FRAUNHOFER IESE

Highlight in 2011	10
Outlook on 2012	14
The Fraunhofer-Gesellschaft	20
Fraunhofer IESE and its Network Partners	22
IESE in Fraunhofer Groups and Alliances	26
Organizational Structure	34
The Advisory Board	36
Personnel and Budget	37

HIGHLIGHT OF THE YEAR 2011

15 YEARS OF INNOVATIVE, APPLICATION-ORIENTED RESEARCH IN KAISERSLAUTERN: FRAUNHOFER IESE LOOKING AMBITIOUSLY TO THE FUTURE

15 years ago, the founding of the first Fraunhofer institution in Kaiserslautern, which in 2000 became the first Fraunhofer Institute in Rhineland-Palatinate, was an important step towards the development of the city as a center of technology. Representatives from science, business, and government celebrated the 15-year anniversary of the Fraunhofer Institute for Experimental Software Engineering IESE, one of the worldwide leading research institutions in its field, on 08 June 2011.

During the celebration at the institute, Minister President Kurt Beck emphasized in his speech the structural importance of Fraunhofer IESE for the technology hub Rhineland-Palatinate: "Fraunhofer IESE is a reliable technology partner for companies in Rhineland-Palatinate. For the state government, Fraunhofer is also a strong partner when it comes to recognizing the scientific and technological potential of a region and to systematically expanding this potential." The Minister President called the development of the science hub Kaiserslautern a "success story" of a cluster policy.

"Fraunhofer IESE as a top research institution is one of the pillars of support for Kaiserslautern's reputation as a center of research and science", confirmed Lord Mayor Dr. Klaus Weichel. "In addition, the institute has made major contributions to the development of jobs in our city in both science and business, as well as to the internationalization of our city." Both "K-Town" and the state of Rhineland-Palatinate are benefiting not only from the reputation that Fraunhofer IESE has earned nationally and internationally through 15 years of successful research work with partners from industry and the public sector, but also from the research results.

The direct benefit of research results for business and society is one of the declared goals of the Fraunhofer-Gesellschaft.

To accomplish this goal, innovation is called for. "The ability to innovate is the major criterion for competitiveness today", stated Prof. Dr. Hans-Jörg Bullinger, chairman of the Board of Directors of the Fraunhofer-Gesellschaft. For a high-wage country such as Germany, there is no alternative to creative minds and to an innovation strategy built on complex products, high quality, and a technological edge. It is not only about following the markets, but also about designing future markets ourselves. New technologies provide the basis for this. "With software and system solutions such as those developed by Fraunhofer IESE in Kaiserslautern, companies in the automotive industry, in health care and medical technology, or in eGovernment will gain the competitive edge that will ensure their future economic success", continued Bullinger.

Thanks to its excellent applied research, Fraunhofer IESE is today considered one of the worldwide leading research institutions in the area of software and systems engineering. "We are seen as a top-notch innovation partner when it comes to establishing new or expanding existing business areas in all software-intensive industries worldwide. This is proven, among other things, by our successful international branches in the USA, Australia, and soon also in Brazil," reported Prof. Dr. Dr. h. c. Dieter Rombach, executive director of Fraunhofer IESE.

However, Fraunhofer IESE is not resting on its laurels after 15 years of successful research work; rather, it has ambitious goals and exciting visions for the future, as stated by its scientific director, Prof. Dr.-Ing. Peter Liggesmeyer: "Fraunhofer IESE has managed to keep the institute's founding topics up to date while adding additional research areas. Strategic industry and research projects and collaborations with international and national partners, and particularly our intensive connection with the University of Kaiserslautern, are the basis for future success", said Liggesmeyer.



FRAUNHOFER IESE

PROCESS MODELING
EXPERIENCE MANAGEMENT
MEASUREMENT

REQUIREMENTS ENGINEERING
ARCHITECTURE
TESTING & REVIEW



Director:
Prof. Dr. Dieter Rombach

Foundation of the Fraunhofer Institute for Experimental Software Engineering as the first Fraunhofer institute in Rhineland-Palatinate



1996

Foundation of the Fraunhofer Center Maryland FC-MD in the USA



1998

Permanent status as Fraunhofer Institute for Experimental Software Engineering IESE



2000

Start of construction on new institute building



2003

15 YEARS OF INNOVATION

MODEL-BASED DEVELOPMENT APPROACHES FOR SAFETY, SECURITY, USABILITY



Two directors:
Prof. Dr.-Ing. Peter Liggesmeyer
joins IESE

MODEL-BASED DEVELOPMENT FOR RUNTIME-ADAPTIVE SYSTEMS WITH QUALITY ASSURANCE



Negotiations on Fraunhofer
Project Center for Software
and Systems Engineering in
Brazil (opening March 2012)



Move to the new
Fraunhofer Center at
Fraunhofer-Platz 1



Intelligent energy manage-
ment: IESE produces its own
solar energy.



Opening of the Fraunhofer
Project Center for Transport
and Logistics in Sydney,
Australia



2005

2009

2010

2011

OUTLOOK ON 2012

MOVING SAFELY INTO THE FUTURE

Contact

Dr. Mario Trapp
 Phone +49 631 6800-2272
 Fax +49 631 6800-9 2272
mario.trapp@iese.fraunhofer.de



Dr. Mario Trapp

Embedded systems are everywhere, and our modern economies and societies would be unable to survive without them. Already today, more than three billion embedded components and devices are manufactured every year, incorporating 98% percent of all microprocessors built. In Germany alone, the market volume amounts to more than 19 billion euros annually, with growth rates of up to eight percent. And this is just the beginning of the success story being written by embedded systems. Self-sustaining individual products will be replaced by cyber-physical systems, which will take over ever more complex tasks through intensive cooperation and seamless integration with classical information systems. Newly emerging product classes, technological innovations, and methodological progress offer both opportunities and challenges. These are addressed by the division "Embedded Systems", which aims to develop solutions for the markets of tomorrow already today.

Quality Certification Center for Innovative Embedded Systems

The result of these changes has been a rapid increase in the innovation density regarding the development of embedded systems. However, this often creates major challenges for companies. Whereas a lot of new functionality can be implemented technically, it is usually very difficult to actually prove quality. Particularly as far as the development of highly reliable and safety-critical systems is concerned, quality assessments that can be accepted by certification bodies are a basic prerequisite for introducing a product to the market. This leads to a bottleneck that obstructs or even prevents the market success of highly promising innovations. Companies are also faced with the challenge of how to convince certification bodies that their innovative technologies are safe. The more innovative the technology used, the more difficult its acceptance during the certification process. The division "Embedded Systems" has therefore been working for many years on developing processes that make it possible to efficiently prove safety and reliability for innovative products. In 2012, this focus area will be expanded with the establishment of a Quality Certification Center, where the institute as an independent authority will perform the necessary quality checks for its customers. Although the center will also perform general quality checks, it will focus on providing safety evidences for innovative products and technologies for which no established quality certification data or processes exist. This will make it possible to create the necessary evidence for establishing safety cases for novel technologies. These quality certifications will allow the customers of the Quality Certification Center to get their innovations certified faster by the appropriate certification bodies, which in turn will allow them to introduce their products to the market faster. By combining the institute's competence in advanced quality certification with the independence of the Fraunhofer-Gesellschaft, the new



Quality Certification Center will close a gap that has existed until now between technology innovation and certifiability.

Security and Reliability in Cyber-Physical Systems

The Quality Certification Center will be an important contribution that will allow bringing new technologies to the market faster and more efficiently. Cyber-physical systems are considered one of the major technologies on which future innovations will be based. However, in order to also exploit the full potential of cyber-physical systems for the development of safe and highly reliable products, numerous technological challenges still need to be addressed first.

An example is the fact that in cyber-physical systems, sub-systems dynamically connect at runtime. These subsystems are built by different manufacturers and vary strongly in terms of the scope of their functions as well as in terms of quality. In addition, the single systems dynamically adapt to the context of their environment. This flexibility and adaptability is one of the main advantages of cyber-physical systems. At the same time, this same flexibility and adaptability is the reason why ensuring the safety and reliability of cyber-physical systems is a challenge. Due to the system adaptations at runtime, the structure and behavior of the cyber-physical system cannot be predicted completely at design time. Therefore, providing quality certification at design time is no longer possible to the full extent. Particularly in the context of safety-critical systems, this requires rethinking and a change of paradigms, since existing approaches are designed in such a way that the overall system is completely checked and approved before introduction to the market. It is therefore not simply a matter of adapting the procedures used to date for use in cyber-physical systems; rather, new approaches are necessary. This leads to numerous issues ranging from the necessary adaptations of the certification and quality assurance processes via new architecture designs to new runtime mechanisms. This makes it particularly important to ensure safety and reliability at runtime, which will go far beyond the capabilities of existing fault tolerance mechanisms. This is especially true since “certification at runtime” appears to be inevitable in the mid-term if we want to fully exploit the possibilities offered by cyber-physical systems that we are envisioning today.

Cyber-physical systems are the basis for many future visions. Safety and reliability in cyber-physical systems are a central research focus at Fraunhofer IESE aimed at allowing these visions to be turned into successful products.

TRENDS IN PROCESS AND QUALITY MANAGEMENT

Contact

Dr. Jens Heidrich
Phone +49 631 6800-2193
Fax +49 631 6800-9 2193
jens.heidrich@iese.fraunhofer.de



Dr. Jens Heidrich

Efficient development processes and high-quality software systems and products are basic prerequisites for staying competitive in a global market. In the future, process and quality management will be faced with new challenges that need to be mastered by an organization if it wants to defend and further expand its position on the market. Processes and quality assurance mechanisms must react to ever shorter business and technology lifecycles and must permit flexible adaptation. Software products and systems are increasingly being developed in a distributed manner in a heterogeneous environment. This is particularly true for cyber-physical systems, where organizations from different domains work together on an integrated solution, each with its own special requirements regarding the integration of different processes and quality management mechanisms. The focus of the division “Process Management” of Fraunhofer IESE is on designing innovative development processes as well as approaches for measuring and predicting product and process properties in order to meet the challenges of tomorrow.

Business/IT Alignment

Understanding software and IT as drivers for innovation and value creation and being able to clearly prove their contribution to an organization’s business goals is becoming ever more important. This is particularly crucial in the context of rapidly changing markets, which require an organization to focus on the most promising areas for its future development. Since 2005, Fraunhofer IESE and its U.S. sister institute CESE (Fraunhofer Center for Experimental Software Engineering) have been working on the development of the GQM+Strategies® approach. This approach supports companies in aligning organizational goals and strategies from the top management level to the operational project level through measurement and in developing corresponding software measurement systems for assessing the success or failure of goals and strategies. Future systems will increasingly not be developed by a single organization, but rather within a consortium of different companies. In order to respond to these developments, the Business/IT Alignment approaches must also be extended beyond the boundaries of a single organization to allow addressing goals and strategies holistically in a distributed, heterogeneous environment.



Quality Models for Cyber-Physical Systems

Software quality is a very abstract term, which is often used synonymously with reliability or defect-proneness. In fact, this term includes a whole series of properties (such as functionality, reliability, usability, efficiency, maintainability, or portability). Quality models (such as ISO 9126 or its successor ISO 25000) describe which quality properties of a software system are important for an organization and how to measure these systematically during the development process and thus master them. Since 2008, Fraunhofer IESE has been collaborating with renowned partners from industry and research on developing quality models for different application domains in the context of the project Quamoco. Future systems will be increasingly developed in a heterogeneous environment where several organizations from different domains are working on one integrated system, which is composed of heterogeneous components. In this context it is particularly challenging to make valid quality statements. Fraunhofer IESE addresses this challenge by focusing on the development of goal-oriented and custom-tailored quality models.

Multi-Disciplinary Process Frameworks

The process landscapes in modern organizations include a variety of different development approaches: from classical, plan-based approaches such as the Rational Unified Process or the V-Modell XT, to agile processes such as Extreme Programming and Scrum. In addition, various requirements exist regarding compliance with standards, ranging from requirements on the general development standard, such as achievement of a specific CMMI or SPICE maturity level, to requirements originating from standards for specific system classes, such as IEC 61508 (Functional Safety) and the respective domain-specific derivatives. Since 2010, Fraunhofer IESE has been working on the issue of multi-process compliance. The goal is to sustainably reduce the effort required for checking compliance with several development standards. Future developments will aim at providing this evidence in a multi-disciplinary environment in which different development approaches from various organizations have to be combined for developing an integrated system as efficient as possible.

INFORMATION SYSTEMS GO MOBILE

Contact

Dr. Jörg Dörr
 Phone +49 631 6800-1601
 Fax +49 631 6800-9 1601
 joerg.doerr@iese.fraunhofer.de



Dr. Jörg Dörr

Information systems of the future will no longer be monolithic systems. To cope with company requirements regarding usability and performance, but especially regarding flexibility and interoperability, our customers rely on new business models and technologies. The seamless integration of IT systems, the use of Clouds, and the integration of mobile end devices into the device landscape are dominating topics already today. The use of new technologies, however, also places new requirements on IT-based solutions, particularly in terms of User Experience and security. This is true for the use of IT systems in classical industries, such as the financial sector, public administration, ERP systems in automotive and mechanical engineering, or the medical field. A particular challenge is the systematic engineering of complex systems containing both information systems and embedded systems. Under the terms “Cyber-Physical Systems” or “Vertical Integration”, new challenges emerge regarding the maximum exploitation of optimization potential and the validation of necessary system qualities. At the same time, the efficiency of software development should also continue to increase.

Integration of Mobile End Devices into Business Systems: More than an App

In 2012, mobile software engineering is a central theme at Fraunhofer IESE, as can be seen in our motto for this year’s CeBIT, “Engineering Mobile Business”. Since 2010, the Research Area “Business Goes Mobile” has been pushing the development of efficient software engineering methods for so-called “business apps”, i.e., apps to support different people involved in business processes. Even though these dedicated apps can be used as stand-alone apps, they must still be integrated into existing system landscapes and generally have high quality in order to support an organization’s business in the best possible way. In 2012, IESE researchers will therefore continue to work on developing a dedicated development methodology that fulfills the requirements of mobile applications regarding the procedures for requirements engineering, architecture, user interface design, and testing. Under the label “GoMobile”, this development methodology provides a multitude of integrated services for industry customers.

Positive User Experience on Mobile End Devices

For many years, Fraunhofer IESE has been developing approaches for the long-term optimization of the Usability and User Experience of business applications. In 2012, one focus will be the user interface design for mobile end devices. The top goal will be to design user interfaces that are custom-tailored to the respective task that is to be performed via the mobile device, as well as for the respective end device – be it a smartphone, a tablet, or both. Attention



will be given to creating a native look & feel on the mobile end devices, since experience has shown that this is what users want. However, this does not necessarily mean that a native mobile application must be implemented. In order to serve several mobile platforms efficiently, Fraunhofer IESE relies on a user interface design methodology that allows developing the different UIs on a joint, platform-independent model up to a certain point, and then exploiting the respective device and platform features optimally later on.

Security at All Times: Full Control over My Data

Today, IT applications and services exchange huge amounts of information provided by users, both in our private lives and in business environments. The results are risks such as identity theft, disclosure of strategic business data, and image loss due to violations of data privacy, as frequently reported in the media. In order to protect private users or company-related information from data misuse, simple forms of access control are no longer sufficient. Fraunhofer IESE therefore relies on innovative mechanisms for data usage control. The intended usage of the data is determined by so-called policies. By modifying the IT systems used and involved, it is possible to monitor and ensure that data can only be used according to their specified policies. In 2012, Fraunhofer IESE will finish the first integrated domain-specific demonstrators for the areas of Ambient Assisted Living (AAL) and for scenarios with mobile end devices and present them to its customers.

Software Development Efficiency

Many companies want to further improve the quality of their product on the one hand, and find out on the other hand whether agile methods deliver what they promise and actually increase development efficiency. Agile processes are often thought to be in contradiction to requirements management. For more than ten years, Fraunhofer IESE has been doing research on requirements engineering; hence we know how crucial good requirements specifications are for the success and quality of a product. Furthermore, we are continually optimizing the efficiency of our requirements engineering methods. On the one hand, we can significantly speed up the requirements elicitation process, since we systematically use information about existing systems during the elicitation of new requirements. This also works for systems that are not well documented, as the information is systematically extracted from the existing systems. On the other hand, we will be using a framework developed by us for the iterative prioritization of requirements in order to be able to steer elicitation into the most promising directions right from the start in the case of large systems. Last but not least, we are optimizing the requirements specification in such a way that roles like architect and user interface designer are not confronted with huge numbers of irrelevant requirements, but are given those requirements that are relevant for them.

THE FRAUNHOFER-GESELLSCHAFT

Address

Fraunhofer-Gesellschaft e. V.
P.O.Box 20 07 33
Hansastraße 27c
80686 München, Germany
info@zv.fraunhofer.de
www.fraunhofer.de

Fraunhofer Locations in North and South America

Brookline, Massachusetts
Cambridge, Massachusetts
College Park, Maryland
East Lansing, Michigan
Newark, Delaware
Plymouth, Michigan
San Jose, California
Santiago, Chile

Fraunhofer Locations in Asia

Bangalore, India
Beijing, China
Jakarta, Indonesia
Selangor D.E., Malaysia
Seoul, Korea
Singapore
Tokyo, Japan

Fraunhofer Locations in the Middle East

Dubai, United Arab Emirates

Fraunhofer Locations in Europe

Brussels, Belgium
Vienna and Graz, Austria
Bozen, Italy
Porto, Portugal

Research of practical utility lies at the heart of all activities pursued by the Fraunhofer-Gesellschaft. Founded in 1949, the research organization undertakes applied research that drives economic development and serves the wider benefit of society. Its services are solicited by customers and contractual partners in industry, the service sector and public administration.

At present, the Fraunhofer-Gesellschaft maintains more than 80 research units in Germany, including 60 Fraunhofer Institutes. The majority of the 18,000 staff are qualified scientists and engineers, who work with an annual research budget of €1.66 billion. Of this sum, more than €1.4 billion is generated through contract research. Two thirds of the Fraunhofer-Gesellschaft's contract research revenue are derived from contracts with industry and from publicly financed research projects. Only one third is contributed by the German federal and Länder governments in the form of base funding, enabling the institutes to work ahead on solutions to problems that will not become acutely relevant to industry and society until five or ten years from now.

Affiliated research centers and representative offices in Europe, the USA, Asia, and the Middle East provide contact with the regions of greatest importance to present and future scientific progress and economic development.

With its clearly defined mission of application-oriented research and its focus on key technologies of relevance to the future, the Fraunhofer-Gesellschaft plays a prominent role in the German and European innovation process. Applied research has a knock-on effect that extends beyond the direct benefits perceived by the customer: Through their research and development work, the Fraunhofer Institutes help to reinforce the competitive strength of the economy in their local region, and throughout Germany and Europe. They do so by promoting innovation, strengthening the technological base, improving the acceptance of new technologies, and helping to train the urgently needed future generation of scientists and engineers.

As an employer, the Fraunhofer-Gesellschaft offers its staff the opportunity to develop the professional and personal skills that will allow them to take up positions of responsibility within their institute, at universities, in industry and in society. Students who choose to work on projects at the Fraunhofer Institutes have excellent prospects of starting and developing a career in industry by virtue of the practical training and experience they have acquired.



Prof. Dr. Hans-Jörg Bullinger
President, Corporate Management



Prof. Dr. Ulrich Buller
Research Planning



Prof. (Univ. Stellenbosch)
Dr. Alfred Gossner
Finance and Controlling, IT



Dr. Alexander Kurz
Legal Affairs, Personnel Affairs



The man behind the name:

Joseph von Fraunhofer

The Fraunhofer-Gesellschaft owes its name to Joseph von Fraunhofer (1787-1826), the successful Munich researcher, inventor and entrepreneur. Born of a family of modest means, the glass-grinding apprentice Joseph von Fraunhofer joined the institute for optics headed by privy councillor Joseph von Utzschneider, who put the young researcher in charge of glass manufacturing at the early age of 22. Joseph von Fraunhofer's major developments include new methods of glass production and processing.

The optical instruments he himself developed, such as the spectrometer and the diffraction grid, enabled Fraunhofer to conduct fundamental research in the fields of light and optics. He was the first scientist to measure the spectrum of sunlight and characterize the appearance of the dark absorption strips: the "Fraunhofer lines". His work as an autodidactic researcher earned him great respect in academia and government, leading to the former apprentice becoming a full-fledged member of the Bavarian Academy of Sciences and Humanities.

FRAUNHOFER IESE AND ITS NETWORK PARTNERS

Fraunhofer IESE fulfills its mission of applied research and technology transfer through close collaboration with users of software engineering technology, providers of new technologies, and strategic partners in national and international collaborations. Thus, IESE actively promotes further development of software engineering technology and its transfer into industrial practice.

International Research Networks

Fraunhofer IESE is a member in several international research associations. The International Software Engineering Research Network (ISERN) with approx. 60 members from science and industry plays an important role in Fraunhofer IESE's international research collaborations. ISERN is a forum for applied software engineering researchers for exchanging the latest research results and experiences.

Further information:

<http://isern.iese.de>



In addition, Fraunhofer IESE is affiliated with the Center for Empirically Based Software Engineering (CeBASE), a project of the National Science Foundation (NSF) in the United States. Other CeBASE members include FC-MD, the University of Maryland, the University of Southern California, Mississippi State University, and the University of Nebraska-Lincoln.

Bilateral research and exchange programs for students and scientists exist with renowned institutions such as:

- Experimental Software Engineering Group at the University of Maryland, USA
- Center for Software Engineering at the University of Southern California, USA
- Universidade Federal da Bahia, Brazil
- Universidade Estadual da Paraíba, Campina Grande, Brazil
- Carleton University, Toronto, Canada
- Clemson University, South Carolina, USA
- Kyungpook National University, South Korea,
- Lancaster University, United Kingdom
- Simula Research Laboratory, Lysaker, Norway
- University of Calgary, Canada
- National ICT Australia Ltd (NICTA), Sydney, Australia
- Bay Zoltan Foundation for Applied Research, Budapest, Hungary
- Poznan University of Technology, Poland
- Universität Malta
- Software Quality Institute at Griffith University, Australia



National Research Networks

The **Science Alliance Kaiserslautern e.V.** is a coalition of ten internationally renowned research facilities in Kaiserslautern. Together they form a highly specialized multidisciplinary network, which provides students, scientists, and cooperation partners from industry, business, and the public sector with innovative solutions based on the newest technologies and methods available.

Members of the Science Alliance are the University of Kaiserslautern, the University of Applied Sciences Kaiserslautern, and eight research institutes, some of which are spin-offs of successful research completed at the University of Kaiserslautern. Their prolific work in the past years has added to the growing reputation of Kaiserslautern as a distinguished location for study, research, and technology.

Further information:
www.science-alliance.de



SafeTRANS e.V. (“Safety in Transportation Systems”) is a Competence Cluster combining research and development expertise in the area of complex embedded systems in transportation systems. SafeTRANS drives research in human-centered design, in system and software development methods for embedded systems, as well as in safety analysis and – for avionics and rail – its integration in certification processes, driven by a harmonized strategy addressing the needs of the transportation sector.

Further information:
www.safetrans-de.org



The cluster “**Software Innovations for the Digital Enterprise**” (or **Software-Cluster** for short) focuses on the region around the software development centers Kaiserslautern, Darmstadt, Karlsruhe, Saarbrücken, and Walldorf. Its objective is to explore and develop the enterprise software of the future. This will enable companies that have only been using ICT as a tool to support their traditional processes to transform themselves into completely digital enterprises where ICT is the major driver for product and process innovations (also see page 100 for further details).

Further information:
www.software-cluster.org







Industrially-funded Collaborations

Fraunhofer IESE's industrial cooperation partners range from global players to small regional companies. They can be grouped into four categories:

- Large national and international organizations looking for support in their mid- to long-term strive for quality improvement in software development.
- Large national and international organizations with their own R&D department, who are looking for competent research partners.
- Medium-sized enterprises, who want to establish improvement programs or who must implement technology changes under very tight budget and schedule constraints.
- Small companies, who want to use proven technology that yields short-term return on investment.

Specialized Services for SMEs

The speed of modern innovations and the rapid changes of economic constraints place high demands on the management of IT companies. A company that wants to survive in the fierce competition is therefore well advised to continually improve both its own development processes and products and the qualification of its employees.

This is where the Software Technologie Initiative e. V. comes in. It offers all participants the opportunity to receive constant and first-hand information about current developments, trends, and background in the area of software engineering. Numerous events serve to acquire and consolidate applicable knowledge, while also offering the chance for people to get to know each other and to communicate with others. As a living network between research and practice, STI e. V. is the regional platform for direct, unfiltered exchange of knowledge, experience, and information in the area of software development.

Objectives:

- Promotion of software technology in small and medium-sized companies in the region
- Bundling of interests regarding the adaptation of research results in the area of software engineering
- Promotion of innovative software development approaches and their transfer into practice

Contact

Andreas Schlichting
Phone +49 631 6800-2270
Fax +49 631 6800-9 2270
andreas.schlichting@iese.fraunhofer.de



Andreas Schlichting

www.sti-ev.de

IESE IN FRAUNHOFER GROUPS AND ALLIANCES

FRAUNHOFER INFORMATION AND COMMUNICATION TECHNOLOGY GROUP

Shorter innovation cycles have turned IT knowledge into a perishable commodity. The Fraunhofer Information and Communication Technology Group (ICT) provides support in the form of customized solutions, consulting, and contract research for new products and services. The Fraunhofer ICT Group comprises 18 institutes as full members (among them also Fraunhofer IESE), including three associated members, representing a workforce of roughly 4000 employees and a yearly budget of approximately 200 million euros. Its central office in Berlin serves as a one-stop shop, referring customers to the appropriate contacts.

The complementary focal fields of the participating institutes cover the entire value chain of the ICT industry. The business areas are:

- Digital Media
- E-Business
- E-Government
- Information and Communication Technologies
- Energy and Sustainability
- Medicine
- Production
- Security
- Financial Services
- Automotive

The alliance comprises the Fraunhofer Institutes for

- Algorithms and Scientific Computing SCAI
- Applied Information Technology FIT
- Industrial Engineering IAO
- Medical Image Computing MEVIS
- Digital Media Technology IDMT
- Experimental Software Engineering IESE
- Computer Graphics Research IGD
- Integrated Circuits IIS (associated member)
- Intelligent Analysis and Information Systems IAIS
- Communication, Information Processing and Ergonomics FKIE
- Heinrich Hertz Institute, HHI (associated member)
- Open Communication Systems FOKUS
- Optronics, System Technologies and Image Exploitation IOSB
- Computer Architecture and Software Technology FIRST
- Secure Information Technology SIT
- Software and Systems Engineering ISST
- Communication Systems ESK (associated member)
- Industrial Mathematics ITWM

Contact

Prof. Dr. Dieter Rombach
dieter.rombach@iese.fraunhofer.de

www.iuk.fraunhofer.de



Prof. Dieter Rombach



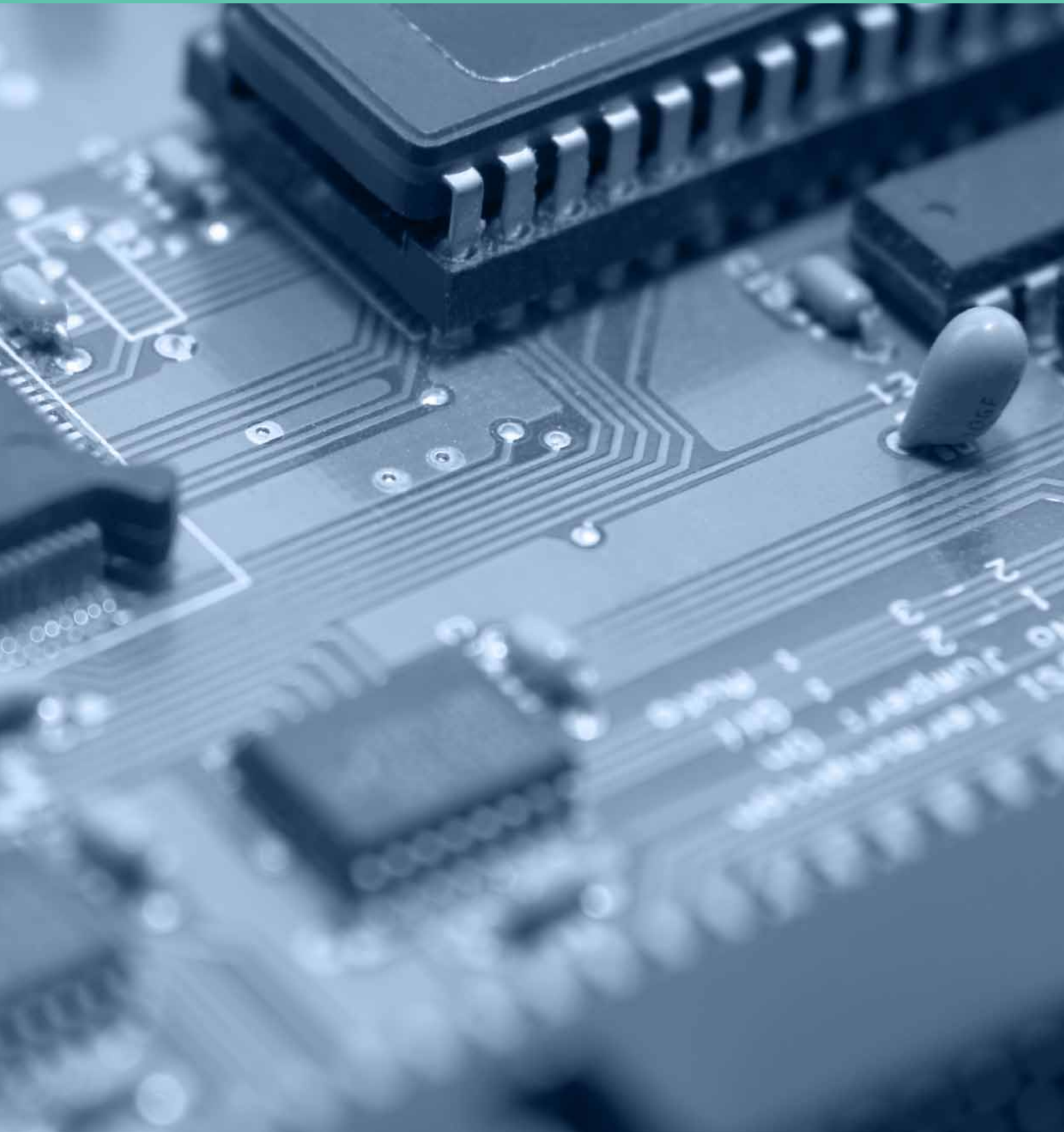



FRAUNHOFER ALLIANCE EMBEDDED SYSTEMS

Embedded systems constitute a central ingredient of technical products, e.g., in transportation, medical technology, automation technology, or in consumer electronics. In recent years, numerous product innovations and unique selling points of technical products "made in Germany" were the result of integrating embedded systems. Especially in the area of high-tech, there is a strong dependency on embedded systems, which is why their economic significance is enormous. As a reaction to the growing requirements and the increasing complexity of embedded systems, the Fraunhofer ICT Group as the largest European research network for information and communication technology pushed the initiative for founding a Fraunhofer Alliance.

Isolated approaches quickly reach their limits when new systems are being developed. In addition to competence in the areas of information technology, electrical engineering, and mechanical engineering, interaction between these disciplines is an essential factor. The Fraunhofer institutes affiliated in the alliance have the necessary comprehensive expertise in practically all topics in the area of embedded systems. The Fraunhofer Alliance Embedded Systems bundles the respective required professional competencies and maps them to the areas of information technology, electrical engineering, and mechanical engineering. At the same time, the alliance acts as a central point of contact for partners from industry, research, government, and the media.

Due to its expertise in the area of embedded systems, Fraunhofer IESE in Kaiserslautern is predestined for a leading role in the alliance. For a long time, safety analyses, embedded systems certification, especially in critical application domains, as well as innovative development methods for embedded systems have been focal research areas of IESE.

The Fraunhofer Alliance Embedded Systems presented itself for the first time on 1 March 2011 in the context of the embedded world Exhibition&Conference in Nuremberg, which is the biggest exhibition of its kind worldwide and the meeting place of the international embedded community.

The alliance comprises the Fraunhofer Institutes for

- Applied and Integrated Security AISEC
- Communication Systems ESK
- Computer Architecture and Software Technology FIRST
- Applied Information Technology FIT
- Communication, Information Processing and Ergonomics FKIE
- Open Communication Systems FOKUS
- Heinrich Hertz Institute, HHI
- Experimental Software Engineering IESE
- Factory Operation and Automation IFF
- Computer Graphics Research IGD
- Integrated Circuits IIS
- Optronics, System Technologies and Image Exploitation IOSB
- Production Technology IPT (Project Group Mechatronic Systems Design)

The speaker of the Fraunhofer Alliance Embedded Systems is Prof. Dr.-Ing. Peter Liggesmeyer, scientific director of Fraunhofer IESE.

Contact

Prof. Dr.-Ing. Peter Liggesmeyer
Phone +49 631 6800-2106
Fax +49 631 6800-9 2106
peter.liggesmeyer@iese.fraunhofer.de

www.embedded.fraunhofer.de



Prof. Peter Liggesmeyer



FRAUNHOFER E-GOVERNMENT CENTER

The Fraunhofer E-Government Center combines the expertise of eight Fraunhofer Institutes in the areas of research needed to build up broad-based eGovernment services in Germany and Europe. Each institute has extensive experience in its particular area of technology and related applications, is already working on several applied eGovernment projects, and is actively involved in the definition of future-oriented, long-term solutions.

The Fraunhofer E-Government Center gives advice to politicians, public administrators, and business people on the conception and development of complete, forward-looking and secure eGovernment solutions and on the realization of service-oriented architectures and standards.

The services it offers also include reorganizing business processes, evaluating and advising on technology, developing future-oriented eGovernment lab scenarios and evolving long-term eGovernment and security solutions, carrying out projects and quality management, helping with standardization, transferring know-how, and training. The Fraunhofer E-Government Center is completely independent of any vendor-specific solutions and political movements.

Each institute in the E-Government Center has many years of experience in the area of technologies and applications and is involved in various eGovernment development projects. As

the regional representative of the E-Government Center in Rhineland-Palatinate, Fraunhofer IESE supports both the public sector and software developing organizations in developing and extending benefit-oriented eGovernment solutions for business, public administration, and citizens. In particular, Fraunhofer IESE offers the following services: execution of needs and ROI analyses, independent quality assurance and support of realization projects (with special attention paid to system architecture, usability, and IT security issues), as well as support in developing eGovernment know-how. In order to ensure optimal coverage of the technological and application-relevant issues, projects are performed in cooperation with other institutes of the Fraunhofer E-Government Center when appropriate.

The Center comprises the Fraunhofer Institutes for

- Applied Information Technology FIT
- Experimental Software Engineering IESE
- Industrial Engineering IAO
- Information and Data Processing IITB
- Intelligent Analysing- and Information Systems IAIS
- Open Communication Systems FOKUS
- Secure Information Technology SIT
- Software and Systems Engineering ISST

Contact

Thomas Jeswein
Telefon +49 631 6800-2106
Fax +49 631 6800-9 2106
thomas.jeswein@iese.fraunhofer.de



Thomas Jeswein

www.egov-zentrum.fraunhofer.de



FRAUNHOFER AMBIENT ASSISTED LIVING ALLIANCE

The institutes of the Fraunhofer Alliance Ambient Assisted Living work together on developing holistic AAL and “personal health” system solutions for comfort, safety, and energy efficiency, for working and living, for health and social networking. The aim is to enable especially elderly or disabled persons or those requiring care to lead long, autonomous lives in their own homes.

The AAL environments being created for this purpose adapt to users’ needs and goals unaided, in a proactive and situation-specific way. “Personal health” components for health-related applications in home or mobile environments allow person-centered, individualized forms of medical care.

The goal is a common system concept that integrates different technologies and applications into modular systems consisting of interoperable components. Accordingly, the AAL Alliance covers the entire value chain from the private user to the professional service provider. Accompanying activities of the AAL Alliance are going on in the areas of research coordination, business model development, and standardization.

The contribution of Fraunhofer IESE is mostly in the area of systematic development of software-intensive systems. For the context of AAL, this includes approaches to the systematic development of integrated AAL solutions with predictable quality, development approaches for adaptable and adaptive systems, system modeling, and analysis, e.g., regarding dependability and usability.

The alliance comprises the Fraunhofer Institutes for

- Applied Information Technology FIT
- Computer Architecture and Software Technology FIRST
- Computer Graphics Research IGD
- Digital Media Technology IDMT
- Experimental Software Engineering IESE
- Industrial Engineering IAO
- Integrated Circuits IIS
- Manufacturing Engineering and Automation IPA
- Microelectronic Circuits and Systems IMS
- Photonic Microsystems IPMS
- Reliability and Microintegration IZM
- Software and Systems Engineering ISST
- Telecommunications, Heinrich Hertz Institute HHI

Contact

Rolf Hendrik van Lengen
Phone +49 631 6800-2103
Fax +49 631 6800-9 2103
rolf.van.lengen@iese.fraunhofer.de



www.aal.fraunhofer.de

Rolf Hendrik van Lengen

ORGANIZATIONAL STRUCTURE

Organizational Structure of the Fraunhofer Institute for Experimental Software Engineering IESE

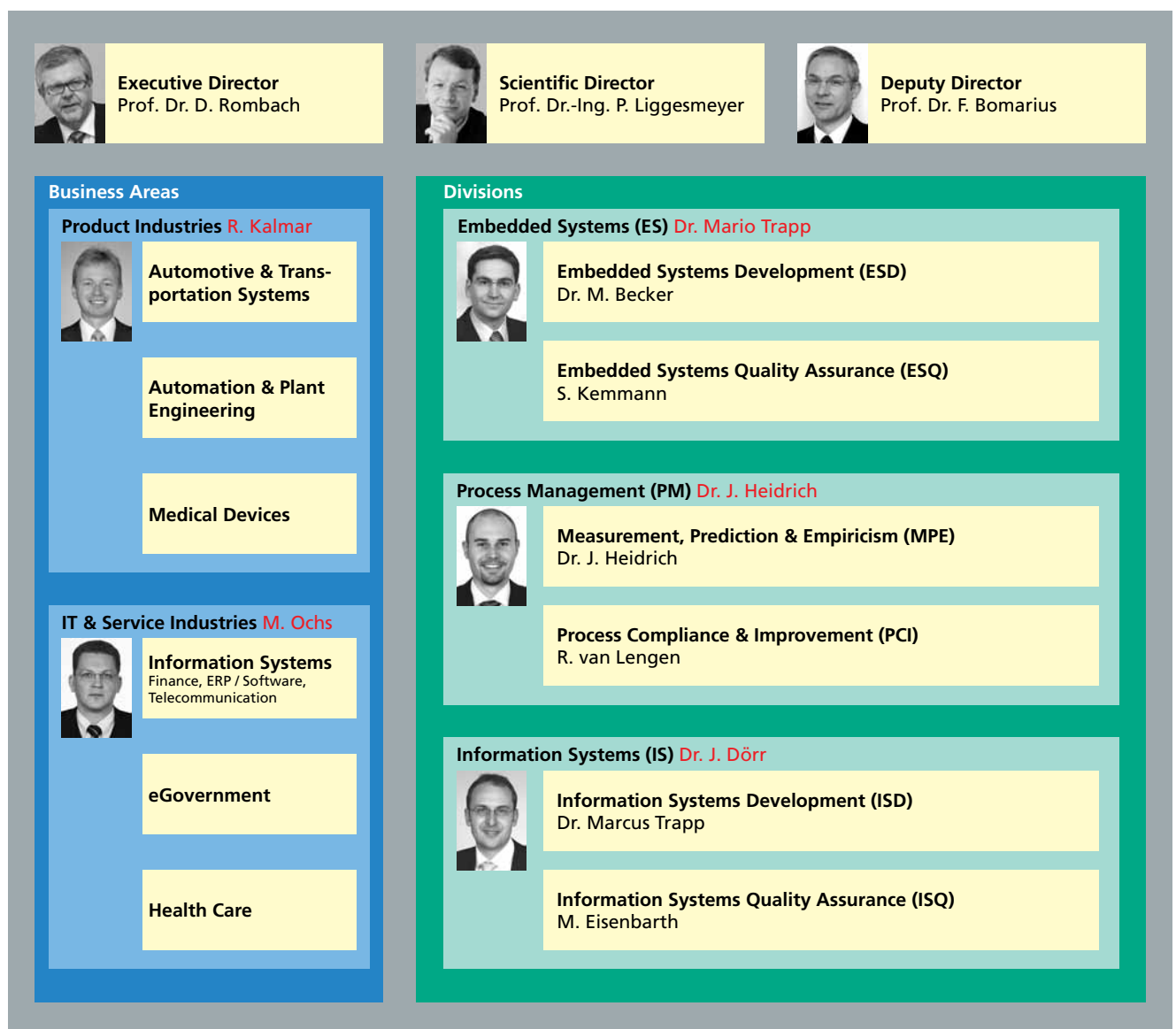



The Fraunhofer Institute for Experimental Software Engineering IESE

The Fraunhofer Institute for Experimental Software Engineering (IESE) develops innovative constructive and analytical processes for the development of dependable software to be used for controlling technical products and processes as well as business processes. These processes are successfully introduced in companies from all branches of industry to increase quality and decrease costs, thus adding business value. Currently, many diverse collaborations exist with companies from the product industries “Automotive and Transportation Systems”, “Automation and Plant Engineering”, and “Medical Devices” as well as from the IT and service industries “Financial Service Providers”, “ERP and Software Producers”, and “Telecommunication” (Information Systems), “eGovernment”, and “Health Care”. Fraunhofer IESE supports companies from all branches of industry in their efforts to achieve “innovation with dependable software”!

Business Areas and Departments

The business areas of Fraunhofer IESE are found in industries with a focus on software in products and on software in IT and service industries. Regarding software in products, the following business areas are addressed:

- Automotive and Transportation Systems
- Automation and Plant Engineering
- Medical Devices

Regarding software in IT and service industries, the following business areas are covered:

- Information Systems, especially Financial Service Providers, ERP and Software Producers, Telecommunication
- eGovernment
- Health Care

Each of these two sectors is led by a Business Area Manager, who is responsible for acquiring new customers.

Fraunhofer IESE has organized its competencies into three divisions. Two divisions are home to the competencies for developing embedded systems with a focus on functional safety, reliability, and availability, and for developing information systems with a focus on usability and security.

- Embedded Systems division with the departments for Development and Quality Assurance
- Information Systems division with the departments for Development and Quality Assurance

In addition, the third division deals with the interdisciplinary competencies of measurement and process improvement:

- Process Management division with the departments for Measurement, Prediction, and Empiricism and for Process Compliance and Improvement

These interdisciplinary competencies are necessary in order to firmly entrench processes for the development of embedded systems and information systems in an organization.

New competence areas are built up in so-called Living Labs, where research takes place concomitant with business model development. Examples of these areas are Ambient Assisted Living or Energy Management.

Fraunhofer IESE receives guidance and counsel from an advisory board consisting of international experts from science and business. For many years, Fraunhofer IESE has been successful on the market. The level of acquisition of third-party funds is on a consistently high level, between 70 and 80%.



Meeting of the Advisory Board on 7 October 2010

THE ADVISORY BOARD

The Advisory Board consists of representatives of research, industry, and government. The board members support the Institute Directors with advice and counsel. (Chairman: Prof. Dr. Ernst Denert, Vice-Chairman: Prof. Dr. Jürgen Nehmer)

Research

Prof. Dr. Victor Basili

Institute for Advanced Computer Science
Department of Computer Science
University of Maryland
USA

Prof. Dr. Manfred Broy

Institute for Computer Science
Technische Universität München

Prof. Dr. Helmut Krcmar

Chair for Information Systems
Computer Science Department
Technische Universität München

Prof. Dr. Jürgen Nehmer

Vice-Chairman of the Advisory Board
Department of Computer Science
University of Kaiserslautern

Prof. Dr. Helmut Schmidt

President
University of Kaiserslautern

Prof. Dr. Mary Shaw

Department of Computer Science
Carnegie Mellon University
Pittsburgh, PA
USA

Industry

Reinhold E. Achatz

Vice President Corporate Technology
Siemens AG
München

Dr. Klaus Grimm

Director Software Technology
Daimler AG
Sindelfingen

Harald Hönninger

Head of Development
Research and Advance Engineering
Robert-Bosch GmbH
Schwieberdingen

Dr. Martin Verlage

Vice Executive Director
vwd group Technology
Frankfurt

Government

Dr. Erasmus Landvogt

Regierungsdirektor, IT Systems
Federal Ministry of Education and Research (BMBF)
Bonn

Stefanie Nauel

Regierungsrätin
Ministry of Economic Affairs, Climate Protection, Energy and Regional Planning, Land Rheinland-Pfalz

Dr. Achim Weber

Director, "International and European Research, Knowledge and Technology Transfer"
Ministry of Education, Science, Youth and Culture, Land Rheinland-Pfalz
Mainz

Private Members

Prof. Dr. Ernst Denert

Chairman of the Advisory Board
Former Chairman of the Board
IVU Traffic Technologies AG
Grünwald

Dr. Hans-Ulrich Wiese

Former member of the Executive Board of Fraunhofer-Gesellschaft e. V.
Gräfelfing

PERSONNEL AND BUDGET

Development of Budget (in T euro).

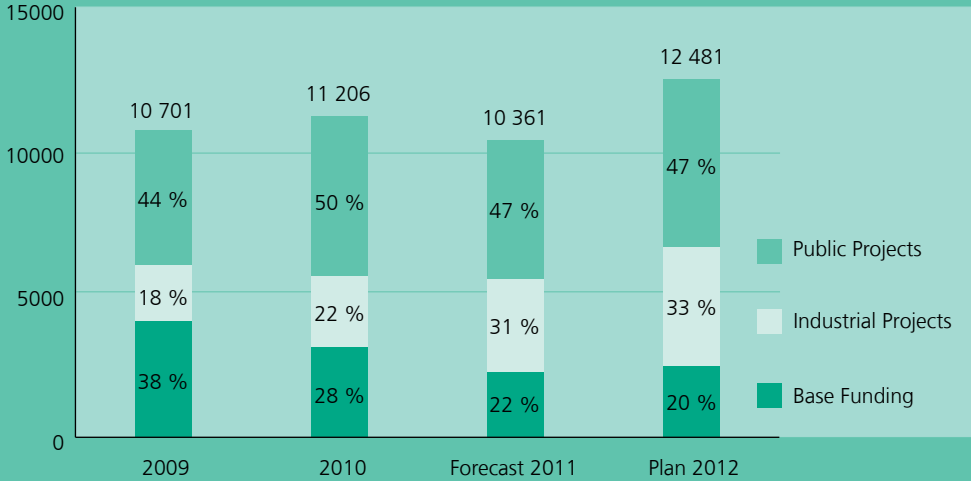

Development of Costs (in T euro).

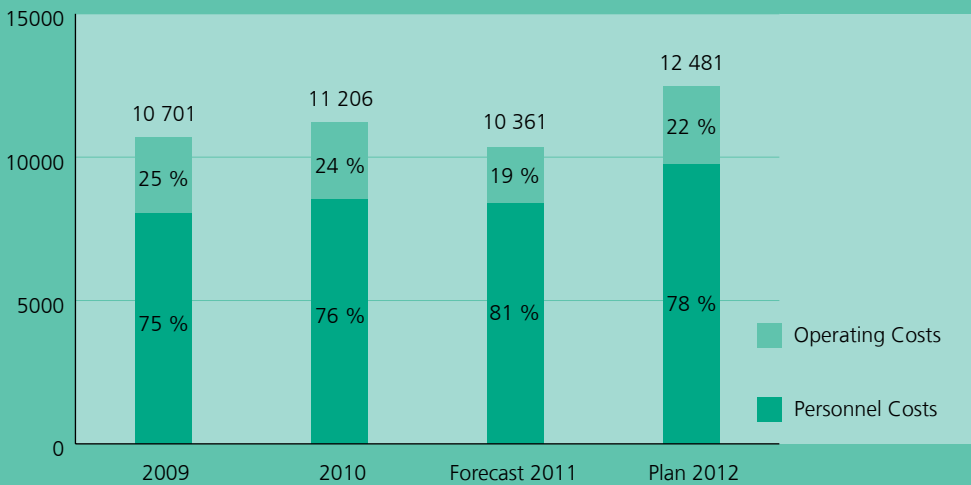

Development of IESE Personnel.

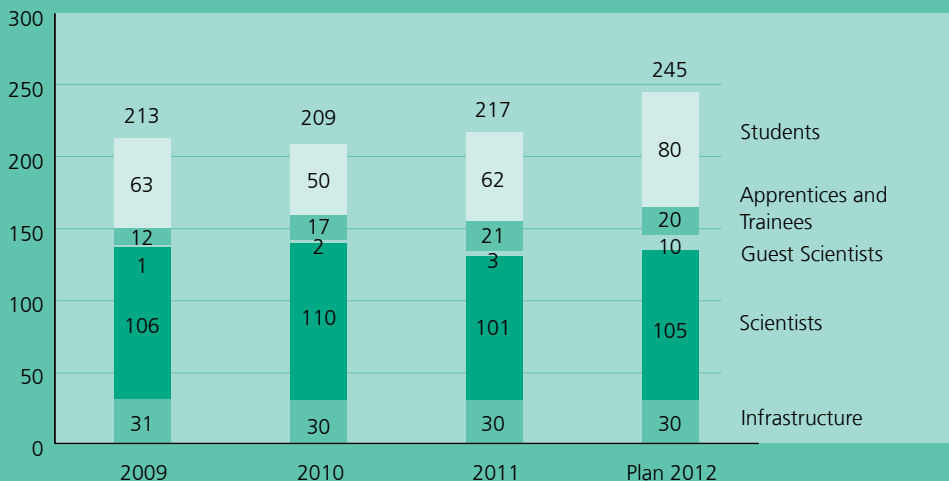

Development of Personnel and Budget

In the context of strategic re-orientation, Fraunhofer IESE focused on its competencies in 2011. The reorganization already showed a positive development in 2011. Thanks to various technical measures, the operating costs could be reduced significantly. The proportion of women among the employees was 27%.

In 2012, the institute plans to hire new employees.



BUSINESS AREAS

The successful implementation of research results in innovative products requires building a solid bridge between technology-oriented researchers and product-oriented companies. Bridging this gap in the best possible way is the task of the business areas of Fraunhofer IESE. Standards, financial constraints and time restrictions, number of items produced, and many other impact factors differentiate areas of application that at first glance appear similar to those not familiar with these topics. Automobiles, a mass product, are produced in much greater quantities than, for instance, airplanes – which are an investment asset. In both cases, we are dealing with transportation systems, but the differences between them have far-reaching consequences regarding the suitability of methods and techniques in software and systems engineering. Business area managers have the broad view necessary to assess research results in terms of their use in specific application areas and to combine them in the best possible ways. Fraunhofer IESE is currently setting its focus on business areas that are important for both technical and business application areas.

Automotive and Transportation Systems	40
Automation and Plant Engineering	42
Medical Devices	44
Information systems	46
eGovernment	48
Health Care	50

AUTOMOTIVE AND TRANSPORTATION SYSTEMS

Contact

Ralf Kalmar
 Phone +49 631 6800-1603
 Fax +49 631 6800-9 1603
 ralf.kalmar@iese.fraunhofer.de



Ralf Kalmar

Software Technology for a World in Motion

Modern technologies for reducing consumption and increasing safety and comfort cannot be realized without electronics and software. The business area “Automotive and Transportation Systems” bundles the offers of Fraunhofer IESE particularly for users and manufacturers in the areas of automotive and rail vehicle manufacturing, aerospace, as well as commercial vehicles of all kinds. The term automotive software engineering comprises processes, techniques, methods, and tools adapted specifically to the requirements of vehicle technology.

The services of Fraunhofer IESE address development activities throughout the entire lifecycle, starting from automobile-specific process models on the basis of established standards (ISO/IEC 12207, ISO 26262) and the use of maturity level models (ISO/IEC 15504, Automotive SPICE, CMMI). Product planning is supported through software product line engineering and architecture standards (keyword: AUTOSAR), which take into account possible variants as well as technology and market requirements.

Special tasks such as configuration of a tool chain, integration of security and safety, or assessment of software product qualities (ISO/IEC 25000) are issues solved by Fraunhofer IESE, as are evaluation of innovative technologies in prototypes or systematic technology transfer for individual process steps.

Customer Benefits:

- Provable process and product qualities
- Adherence to safety and quality requirements
- Cost-efficient management of many product variants
- Competitive development productivity

Example Projects:

John Deere: Operator in the
 Loop p. 68
 SPES2020 p. 74
 ARAMiS p. 76
 John Deere: Grower’s
 Notebook p. 86
 automotiveHMI p. 94
 Project Center Australia p. 116

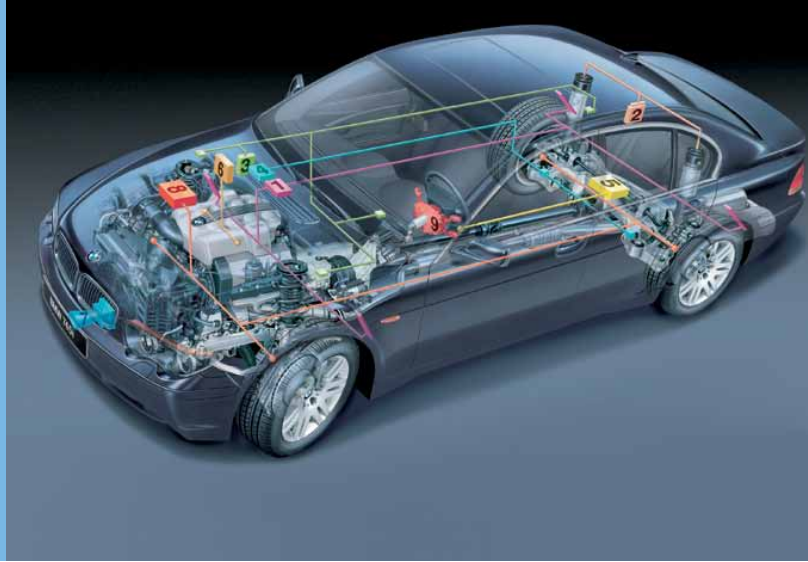

Competence in Software and Systems Engineering, Vertical Integration

Current and future systems are increasingly interconnected. The vertical integration from the IT system to the vehicle places high requirements on safety and reliability - a challenge that the software engineers of Fraunhofer IESE eagerly embrace.

SOFTWARE DEVELOPMENT

Requirements Management

We help you to structure even complex specifications and to ensure traceability in the process with tools such as DOORSTM.

Requirements Analysis, Specification-based Quality Assurance

We support you in developing high-quality requirements and specification documents and in mastering especially non-functional requirements.

Software Product Lines

We assist you in adapting software architectures to efficient reuse while taking advantage of cost- and quality-relevant effects.

Component Design

With our support, you can use efficient modern architectures and modeling languages such as Matlab® and develop runtime- or memory-critical applications without any problem.

SOFTWARE QUALITY MANAGEMENT

Process Assessments

We accompany you in planning and using data-based improvement programs on the basis of CMMIL and Automotive SPICE.

Software Architecture Evaluation and Restructuring

We support you in evaluating and restructuring your software architecture, taking into account special constraints such as runtime behavior or memory requirements.

Checking Techniques for Requirements, Design and Code

Software can already be checked before tested semi-automatically by using either appropriate models or performing structured reviews. We show you how to do this.

Software Measurement Systems

We make software quality measurable with systematically derived metrics - which means benefits for you.

Testing and Test Automation

Many tests can be automated and repeated. We support you in selecting and using appropriate methods, such as model-based testing.

Software Simulation

Testing a subsystem early in terms of its interfaces can be done via virtual integration and simulation.

Security Analyses

We perform thorough security analyses of your systems and help you to avoid vulnerabilities.

Safety Analyses

We design and support analyses for systems that must comply with defined requirements, e.g., in accordance with ISO /IEC 61508 or ISO 26262.

AUTOMATION AND PLANT ENGINEERING

Contact

Ralf Kalmar
Phone +49 631 6800-1603
Fax +49 631 6800-9 1603
ralf.kalmar@iese.fraunhofer.de



Ralf Kalmar

Example Project:

KSB Pumpen

p. 72

Modern Software Development

Decentralized and intelligent control systems, modular plants, small lot sizes, individual manufacturing according to customers' wishes, extensive variation management – the increasing ubiquity of PCs and wireless data transfer are just some of the trends in automation and plant engineering. Classical hardware tasks are increasingly taken over by software, partly for reasons of efficiency and costs, partly due to the necessarily higher complexity, which leaves no other choice than to shift functionality from hardware to software.

It goes without saying that quality must continue to be ensured in this transition: The high standards that have existed for decades in terms of the quality of machines, plants, and automation technology must also apply to software. Only if software is developed according to comparable, engineering-style principles can it conform to the high expectations of the plant engineering and automation industries.

Fraunhofer IESE as one of the worldwide leading research institutions in the area of software and systems engineering offers customers and research partners its expertise in the entire range of modern engineering-style software development. From embedded systems to interactive systems – Fraunhofer IESE studies, develops, and adapts software development processes, measurement methods, test procedures, and algorithms in order to realize innovative products for and with its customers.

Customer Benefits:

- Modern, engineering-style software development
- Adherence to safety and quality requirements
- Controllable complexity and measurable quality

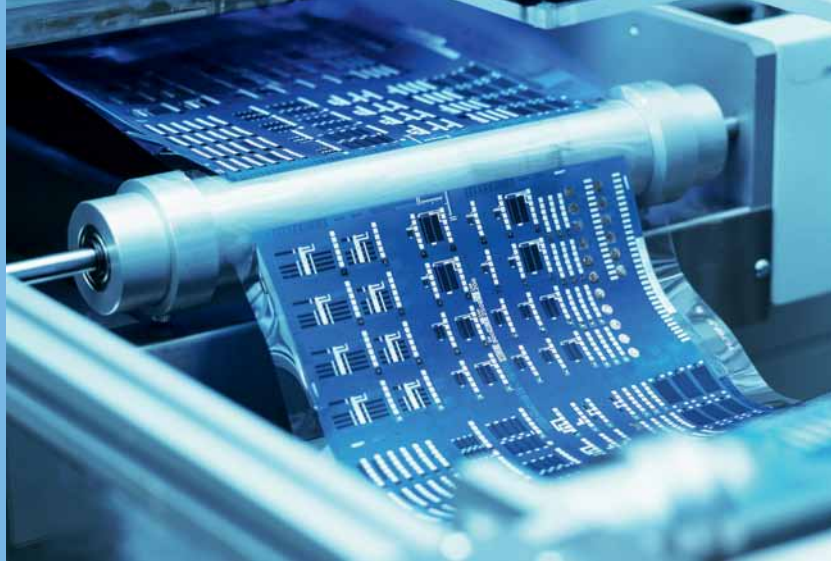

Competence in Software and Systems Engineering

Software engineering means developing software in an engineering-style, systematic manner in accordance with established or standardized processes and procedures. It allows measuring the quality of software and proving adherence to requirements, such as those regarding the safety and reliability of software-supported plants. Fraunhofer IESE offers the methodological competence, the creativity, and the spirit of research needed to develop modern concepts and innovative products with the help of software engineering.

SOFTWARE DEVELOPMENT

Our software and system construction offers you a variety of solutions that are easy to integrate and that will help you to ensure the required qualities during development already.

Software Product Lines

The product line approach PuLSE®, for instance, helps you to reduce unnecessary complexity in variant-rich systems, to make strategic use of reuse potentials, and thus to avoid expenses. Specific variants address special customer wishes – the challenge posed by the increasing complexity of your product world is met by Fraunhofer IESE with variation management processes.

Requirements Management

Incremental requirements engineering means you can be sure that requirements on new hardware and software versions will be elicited and assessed completely, in order to balance user requirements and company goals with the lowest possible change effort.

Usability Engineering

Professional usability engineering measurably increases the satisfaction of the users of your hardware and software by ensuring that the structure and design of user interfaces are oriented towards their requirements, tasks, and wishes. Fraunhofer IESE considers usability and user experience as a precisely specifiable construction goal.

Model-based Development

Continuously model-driven development with SysML or UML allows controlling complex systems with the help of view creation, automatic analyses, and code generation. We assess and restructure complex software and system architectures for you, taking into account non-functional characteristics as well.

SOFTWARE QUALITY MANAGEMENT

Test Automation

Continuous, especially automated testing in conjunction with systematic inspections optimizes quality assurance in the software development process and allows saving costs thanks to early elimination of defects.

Software Process Improvement

The range of services offered by Fraunhofer IESE also includes systematic SWOT analyses and evaluations of your development processes, proofs of process conformance, well-grounded safety analyses, as well as support in increasing your process maturity (CMMI, SPICE). We plan and implement improvement measures for you.

Software Measurement Systems

Through the use of defined metrics, which we derive in a systematic manner adapted to your demands, quality aspects can be expressed in concrete statements. Furthermore, we develop customer-specific software measurement systems and IT-Business Alignment measurement processes.

MEDICAL DEVICES

Contact

Ralf Kalmar
 Phone +49 631 6800-1603
 Fax +49 631 6800-9 1603
 ralf.kalmar@iese.fraunhofer.de



Ralf Kalmar

Software-based Systems for Health and Quality of Life

The domain of medical devices faces particular challenges: The market demands innovative products in less and less time, which constantly increases the complexity and networking of the systems. Yet, absolute reliability and safety of the systems and the (embedded) software are required. There is hardly any other area of our daily lives where computer technology is so close to humans, and consequently, mistakes can have very serious effects.

Our software and systems engineering approach supports you all the way from the elicitation of requirements on the medical device to validation. Together with our customers, we develop innovative solutions for software development that efficiently fulfill the requirements of IEC 62304, DIN EN 60601-1-4, and ISO 12207, and provide assistance in systematically implementing them in daily practice. We integrate future-oriented methods and techniques that ensure quality requirements (e.g., in accordance with ISO/IEC25000 efficiently and economically). Safety is the top priority in this respect. We use new methods to support you in performing risk management according to ISO 14971 for software, and to use techniques such as Failure Mode and Effects Analyses (FMEA) and Fault Tree Analyses (FTA) for analyzing software safety. Custom-tailored quality management approaches (e.g., similar to ISO 13485) are defined as supporting processes.

Customer Benefits:

- Higher safety of the software and thus of the medical devices
- More efficient development and faster time to market
- Reduction of the development and quality assurance costs
- Measurable quality

Example Projects:

Eckert & Ziegler	p. 70
Project Center Brazil	p. 118
NUTES – Brazil	p. 120
MUNDUS – EU	p. 124



Competence in Software and Systems Engineering

Fraunhofer IESE provides support for manufacturers of medical devices during all phases of software and system development.

SOFTWARE DEVELOPMENT

Requirements Management

We support you in eliciting requirements and in developing suitable requirements specifications as well as in managing the requirements.

Usability Engineering

With our expertise, we support you in ensuring that usability is considered during development, and in integrating it into the software and systems lifecycle (IAW EN 60601-1-6 and 62366).

System and Software Architectures

The specification and implementation of future-oriented architectures is one of our core competencies. This also includes the evaluation and restructuring of your existing software architecture, taking into account special constraints such as runtime behavior or memory requirements.

Software Product Lines and Reuse

We support you in defining and introducing the idea of software product lines, and in defining suitable and safe reuse concepts.

SOFTWARE QUALITY MANAGEMENT

Risk Management

The team of Fraunhofer IESE supports you in the standard-compliant implementation of ISO 14971 requirements by defining and implementing a risk management process for software that is adapted to your context and the corresponding documentation.

Safety Analyses

We help you to select and use adapted techniques such as FMEA, FTA, or introduce modern processes such as component fault trees in your organization.

Development Processes

We support you in the standard-compliant definition (e.g., IEC 62304, ISO 12207, V-Modell), structuring, documentation, and implementation of development processes and in the selection of methods, tools, and techniques that are suitable for passing certification procedures.

Static Quality Checking Techniques

Together with you, we define appropriate and innovative processes for verification in parallel to development.

Model-based Testing and Test Automation

We support you in the design and introduction of model-based testing techniques for embedded software, focusing in particular on test automation aspects.

Quality Management

We support you in defining, structuring, and establishing a standard-compliant quality management system for your software development in the style of standards such as ISO 9000-3 or ISO 13485, or the FDA Quality System.

Software Measurement Systems

Through the use of defined metrics, which we derive in a systematic manner adapted to your demands, quality aspects can be expressed in concrete statements.

INFORMATION SYSTEMS

FINANCE – ERP / SOFTWARE – TELECOMMUNICATION

Contact

Michael Ochs
 Phone +49 631 6800-1604
 Fax +49 631 6800-9 1604
 michael.ochs@iese.fraunhofer.de



Michael Ochs

Software in the Age of Information

Information systems permeate our daily lives in many areas. Especially in the areas of eCom-merce and eBusiness, we carry out many everyday tasks using online shops, auction platforms, or online banking systems. Company-internal information systems, in particular, such as ERP, CRM, accounting and billing systems support and automate business processes and thus per-form millions of transactions each day.

Neither operators nor users pay much attention to the technology of these highly complex soft-ware-based systems and their multiple interactions, and yet, modern business life is simply in-conceivable without functional, secure, and user-friendly software operating in the background. Using existing potential to increase efficiency and quality in the development and operation of information systems helps to optimize business processes in a sustainable and cost-efficient manner. Mobile services and applications as part of multi-channel strategies are an important means for making information available to customers and users independent of place and time and provide optimal and reliable support for their actions and decisions, which leads to a sig-nificant increase in flexibility and agility.

The services offered by Fraunhofer IESE range from development activities for large, heteroge-neous, distributed information systems via classical applications to mobile applications. This also comprises the design of systems on the level of coarse-grained and fine-grained requirements, taking into account non-functional requirements, usage designs that integrate business and user goals, User Experience design and (service-oriented) software architectures. Agile principles as well as innovative and proven state-of-the-art methods are also used here to increase the benefits for you as a customer. In quality management, Fraunhofer IESE is your competent and reliable partner for process management and optimization, governance and compliance topics, and the management of organizations and projects via key performance indicators (KPI) rang-ing from the strategic to the operational level. Here, too, we systematically integrate best prac-tices from the area of agile methods with best practices from proven standards such as CMMI®, V-Modell® XT, SPICE, and ITIL. Goal-oriented quality assurance through integrated inspections and testing as well as IT security audits and the definition of security concepts round off our portfolio of services.

Example Projects:

DEviSE	p. 78
Murex	p. 80
Multi-Touch	p. 84
Accenture CAS	p. 88
DESY	p. 90
Insiders	p. 92
Attract	p. 98
Software Cluster	p. 100
FibuNet	p. 102
IPA/SEC – Japan	p. 122

Customer Benefits:

- Provable product quality in all important aspects starting from the design phase already
- Competitive productivity for software and application development
- Optimized, controllable, agile, and risk-minimizing IT and software processes
- Controllable complexity of systems and applications



Competence in Software and Systems Engineering

Consistent and economical processes characterize the work of our institute, which transfers state-of-the-art validated scientific results in combination with best practices into industrial practice – information systems and processes in top quality, ready for the future.

INFORMATION SYSTEMS DEVELOPMENT

Requirements Specification and Management. In every other failed software project, some of the reasons for the failure can usually be found in the requirements. We support you in eliciting and specifying requirements on the basis of our proven approach Satisfy. This guarantees traceability and minimalist documentation of the necessary requirements decisions. In addition, functional as well as non-functional requirements are taken into account.

User eXperience. Today, good usability of information systems alone is no longer enough for achieving success among users. With our proven approach UXelerate, we support you, on the one hand, in evaluating existing systems and improving them based on such an analysis. On the other hand, we help you to develop information systems in such a way that the users have a positive User Experience.

Architecture-Centric Engineering. The architecture of your information system is the key to mastering complexity and to efficiently fulfilling many requirements. This is especially true for quality requirements and technical constraints. With our successful approach ACES we support you in defining and evaluating architectures even for complex information systems.

Business Goes Mobile. Multi-channel strategies and mobile services are becoming more and more important. We develop prototypes for mobile devices to help you make decisions and use these as a basis for developing an entire app. We are your competent partner for your mobile product and service strategy and for the selection of an adequate mobile software platform and development environment. Go mobile!

Variation Management. Complexity is often the result of a great multitude of variants and customer-specific configurations of software products. With our successful PuLSE™ approach, we support you in establishing, developing, and managing software variants.

SOFTWARE QUALITY MANAGEMENT

Process Management. Processes constitute a success factor for the quality of software. Based on a process analysis, we detect strengths and weaknesses in your processes so that improvement potentials and established best practices can be recognized. Actions for improving your processes can be defined systematically and can be implemented later on, which will increase the efficiency and quality of your processes in the long run.

Measurement, Key Performance Indicators, and Prediction Models. Transparency from the strategic to the operative level is an important factor for successful organizational control. We work with you on designing customized KPI systems that improve transparency and controllability – and enable you to predict certain attributes such as quality.

Effort Estimation and Benchmarking. We support you in estimating the effort required for your software projects, in identifying effort drivers, and in performing productivity benchmarking of projects. To do so, we use our proven CoBRA® method, which combines expert knowledge with measurement data and supports you in recognizing and controlling risks in a project early on.

Integrated Testing and Inspections. We help you to focus and reduce your testing efforts by coordinating testing activities with constructive activities such as requirements analysis. In addition, early quality assurance measures such as inspections provide important information on how to focus testing activities. We also support you in deriving test cases from requirements.

Security Audits and Security Concepts. Security standards such as PCI-DSS or IEC 15408 keep coming up with ever new requirements on systems and development. Security gaps must be avoided, since they result in a loss of trust and can negatively affect a company's business success. We define security concepts and evaluate systems and concepts in terms of relevant security requirements.

eGOVERNMENT

Contact

Thomas Jeswein
Phone +49 631 6800-2106
Fax +49 631 6800-9 2106
thomas.jeswein@iese.fraunhofer.de



Thomas Jeswein

Example Project:

P23R

p. 96

eGovernment Solutions for Public Sector and Business

The public sector with its more than four million employees represents one of the largest “business sectors” in Germany. It has to balance regulatory constraints, economic feasibility, and quality of service for its customers. Whether new IT solutions meet with success depends most of all on how well the public sector, business, government, and IT collaborate.

Whereas during the early years of eGovernment, the citizen as a customer of the public sector was the main focus of developments, recent years have seen a growing shift of this focus towards the interface between the public sector and business. This is where the highest gains in efficiency are expected.

ROI analyses performed prior to implementation projects ensure a project’s return on investment. Using systematic and integrated requirements management and involving all stakeholders early on creates the prerequisites for high acceptance of a system. The adaption of the process model V-Modell® XT to a development organization and support for a standard-compliant process ensure that projects are performed efficiently. Service-oriented, standards-based architectures allow the integration of legacy systems and guarantee reuse and interoperability.

Customer Benefits:

- Needs-oriented and secure software systems
- Implementation of eGovernment strategies on the basis of empirically determined priorities
- Asset protection through future-proof, interoperable technologies
- Transparent design and development decisions

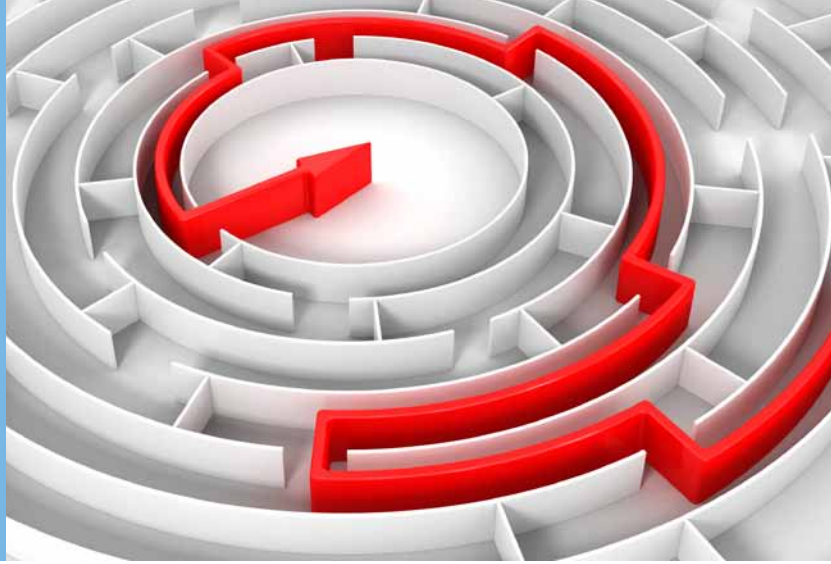

Competencies in Software and Systems Engineering

Fraunhofer IESE assists partners from all levels of government and public institutions on their way to becoming a high-performance service provider for business and citizens. It provides advice to the public sector and to businesses on how to optimize their joint business processes, focusing on proving the benefits for the user. Concentrating on selected business sectors allows responding to their specific requirements and bundling online services in a way that is appropriate for each sector. A wide range of services provides support in planning and realizing needs- and future-oriented eGovernment solutions.

ROI Analyses

We use the screening method developed at Fraunhofer IESE to support you in identifying, evaluating, and prioritizing process chains between business and the public sector. Extended ROI analyses permit assessing the return on investment of an IT project. Effort estimates performed prior to development projects provide the basis for deciding whether to develop on one's own or join a development alliance.

Needs Analyses and Subcontractor Support

How well a system is oriented towards the demands of the user is a decisive prerequisite for how well it will be accepted later on. We support you in eliciting these demands by involving all stakeholders and in formulating the functional and non-functional system requirements. Based on these requirements, we develop bidding documents and provide support during the subcontractor process (esp. in accordance with the UFAB regulation).

Adaptation and Use of the V-Modell® XT

Applying the V-Modell® XT, which was developed with the participation of Fraunhofer IESE, increases the quality of project results while minimizing project costs and risks. We support you in successfully planning and performing projects in accordance with the V-Modell® XT. This also includes the adaptation of the V-Modell® XT to the specifics of your software development organization.

System and Software Architectures

The use of open standards in the context of Service-oriented Architectures (SOA) ensures the interoperability of your systems. We support you in designing and implementing future-oriented architectures and in evaluating and restructuring your existing software architecture. We develop organization-specific concepts for the introduction and operation of SOA.

Security

We support you in designing secure software systems, in checking system security in terms of compliance with BSI basic IT protection, and in planning and checking secure IT infrastructures, e.g., by simulating system attacks.

Usability

Deficiency analyses of your user interfaces based on known usability problems and pilot tests with users from representative user groups permit us to provide a solid empirical assessment of usability. Tests in our "Assisted Living Laboratory" allow us to evaluate the suitability of a given system especially for elderly people.

HEALTH CARE

Contact

Michael Ochs
Phone +49 631 6800-1604
Fax +49 631 6800-9 1604
michael.ochs@iese.fraunhofer.de



Michael Ochs

Example Project:

ZLB

p. 82

Software Technology for Innovative Health Care

Our health care system is currently undergoing dramatic changes. The demographic development, the scarcity of public funding concomitant with the increasing demand for health services, a rapidly developing information and communication technology, and last but not least, regulatory requirements stipulated by law create challenges for the system on various levels.

The use of information technology in the health care sector aims at digitally linking all stakeholders and processes in health care. This includes both software-based applications and the process workflows supported by them.

Modern information systems effectively support automated data elicitation and communication processes and thus make a major contribution to improving quality and increasing efficiency in health care.

Fraunhofer IESE provides support to all stakeholders in the health care sector when it comes to developing and testing software-based innovations. The institute assists its customers from the health care domain in developing complex information systems as well as in implementing domain-specific requirements on modern process management.

Customer Benefits:

- User-oriented software systems
- Controllable complexity and variants
- Provable safety and quality requirements
- Provable process and product quality



Competence in Software and Systems Engineering

The development and quality assurance of software using established methods and standardized software engineering processes form the basis for innovative software systems in health care.

SOFTWARE DEVELOPMENT

Requirements Analysis and Management

We support you in developing high-quality requirements and specification documents. The renowned requirements approach Fraunhofer TORE guarantees that you will get traceability, already integrated usability, and minimal documentation of the necessary requirements decisions.

Usability and User Experience

We optimize the usability of your systems already during development or detect weak spots in the finished product. Using our proven methods, we collaborate with you on developing systems that not only provide support for the user, but also deliver a positive User Experience. This is beneficial for the user, but has also been proven to further the business goals of your organization, and thus will contribute to long-term business success.

Architecture-Centric Engineering

With our successful Fraunhofer ACES approach, we support you in defining and evaluating architectures for complex information systems. The iterative, scenario-based procedure allows you to master the complexity of architecture definition and migration and to make reliable predictions regarding critical system properties early on.

Software Product Lines

With our PuLSE® approach, we support you in defining and introducing the concept of software product lines and in defining suitable and safe reuse concepts. PuLSE® helps you to reduce the unnecessary complexity of systems with many variants, make strategic use of reuse potentials, and thus avoid excess costs.

SOFTWARE QUALITY MANAGEMENT

Checking Techniques for Requirements, Design, Code

We enable early quality assurance for your documents in the software development cycle through the use of the Fraunhofer tool DETECT in order to avoid cost-intensive rework in a later development phase.

Quality Management

We support you in defining, structuring, and establishing a standard-compliant quality management system for your software development in the style of standards such as ISO 9000-3 or ISO 13485 or the FDA Quality System.

Safety Concepts

We support you in determining your safety requirements in terms of pertinent guidelines and standards and define infrastructure and software concepts together with you, or assess existing systems and concepts in terms of the relevant safety requirements and standard compliance.

Improvement Programs based on Measurement Data

In cooperation with you we determine the potential need for optimization in your development processes on the basis of empirical findings. This makes it possible to capture and assess even such aspects as method efficiency and acceptance, which are otherwise hard to specify quantitatively.



DEPARTMENTS

The divisions and departments of Fraunhofer IESE are the central pillars on which the institute's research topics are based. The major restructuring that took place in 2010 and 2011 in these areas is now complete. The new division structure combines work on Embedded Systems on the one hand and activities in the area of Information Systems on the other hand. Particularly for the many industry partners of Fraunhofer IESE, this makes it easy to find a match to the structure of the institute.

Research work related to both embedded systems and information systems or work that is independent of the type of system takes place in the division Process Management. The divisions Embedded Systems and Information Systems are each divided into two departments focusing on development methodology on the one hand and quality assurance on the other hand. This division corresponds to the structures found in industry and therefore facilitates collaboration even more. The division Process Management is divided into a department for measurement, prediction, and empiricism and another department for process compliance and improvement. The new structure reflects the current needs and allows for further strengthening of the important research areas of Fraunhofer IESE.

DIVISION EMBEDDED SYSTEMS	55
Embedded Systems Development (ESD)	56
Embedded Systems Quality Assurance (ESQ)	57
DIVISION PROCESS MANAGEMENT	59
Measurement, Prediction and Empiricism (MPE)	60
Process Compliance and Improvement (PCI)	61
DIVISION INFORMATION SYSTEMS	63
Information Systems Development (ISD)	64
Information Systems Quality Assurance (ISQ)	65

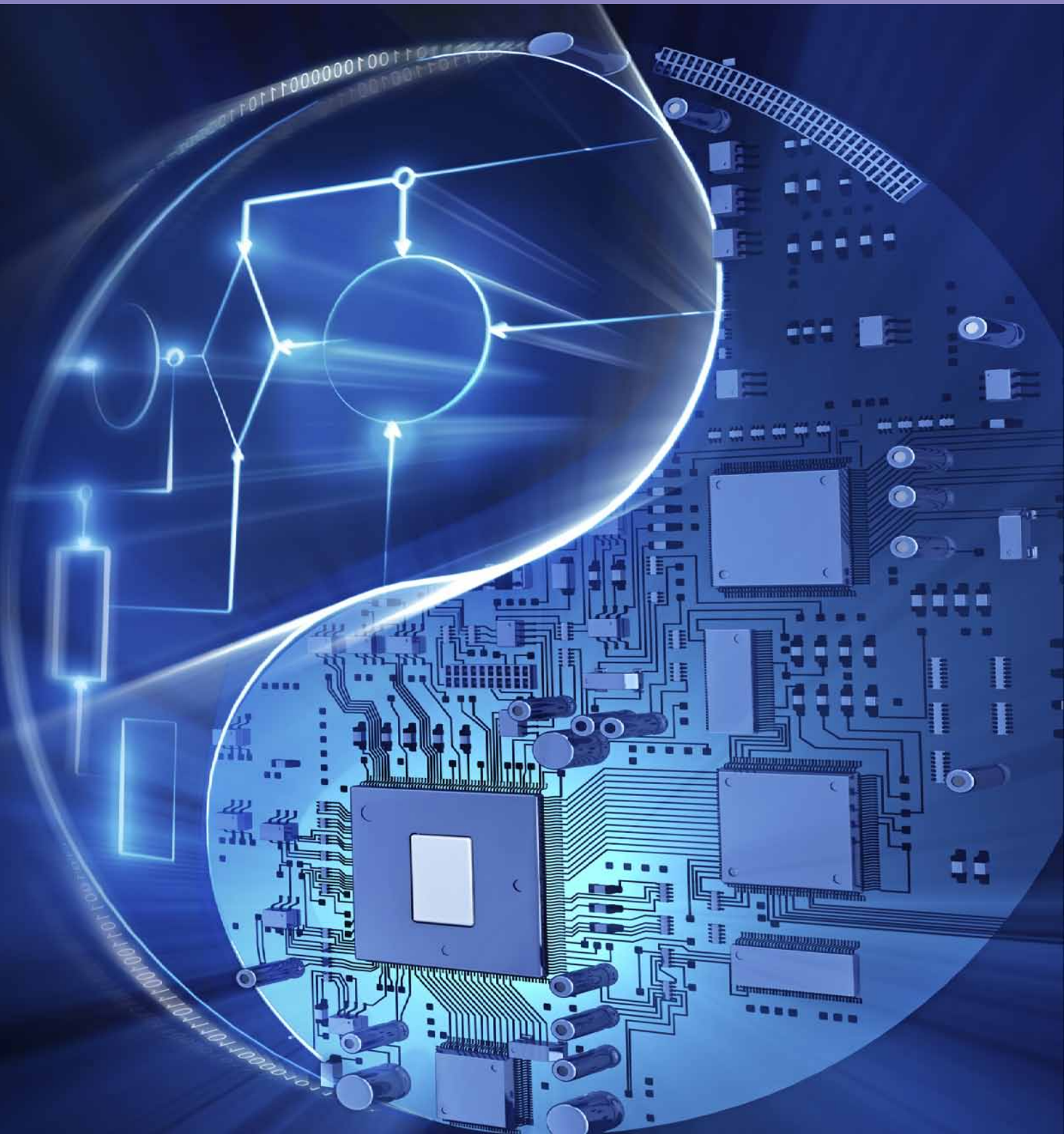

DIVISION EMBEDDED SYSTEMS

Hidden in transportation systems, medical devices, consumer goods, and almost all other technical products, embedded systems are performing essential tasks that make our daily lives safer and more comfortable. Every year, more than three billion embedded components and devices are manufactured, incorporating 98% percent of all microprocessors built. Embedded systems are omnipresent, and our modern economy and society would be unable to survive without them.

The requirements on the reliability and functional safety of such systems are correspondingly high. Failures can rarely be tolerated – particularly when such failures might jeopardize people or the environment. At the same time, the complexity of these systems is increasing ever faster. They are tightly interconnected, developed in a distributed manner, and have to fulfill numerous, sometimes contradictory, functional and non-functional requirements.

In order to meet these challenges, the division “Embedded Systems” focuses on innovative methods and techniques for developing highly reliable and safe systems in a cost-efficient manner.

Division Head

Dr. Mario Trapp
Phone +49 631 6800-2272
Fax +49 631 6800-9 2272
mario.trapp@iese.fraunhofer.de



Dr. Mario Trapp

Example Projects:

John Deere: Oil	p. 68
Eckert & Ziegler	p. 70
KSB Pumpen	p. 72
SPES2020	p. 74
ARAMiS	p. 76
NUTES – Brazil	p. 120

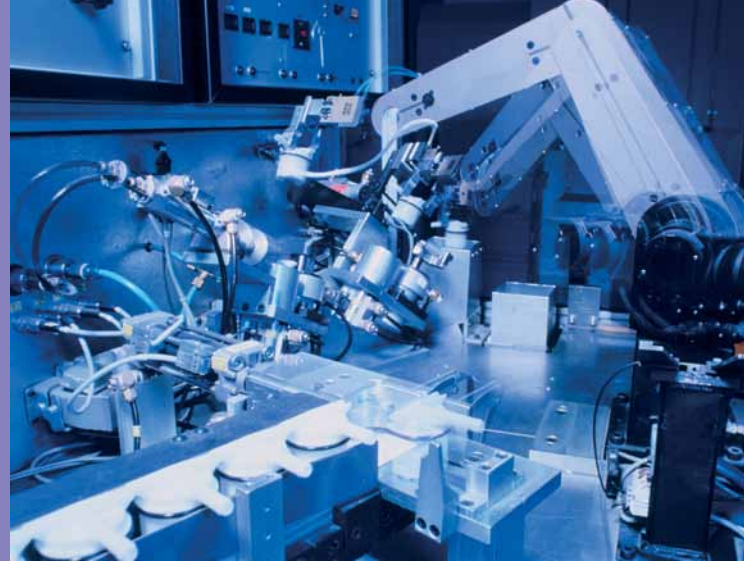

Department Head

Dr. Martin Becker
 Phone +49 631 6800-2246
 Fax +49 631 6800-9 2246
 martin.becker@iese.fraunhofer.de



Dr. Martin Becker

EMBEDDED SYSTEMS DEVELOPMENT (ESD)

In order to be able to develop such highly reliable and safe systems in a cost-efficient manner, development must focus on system quality right from the outset. This means that efficient support is needed for the developers to allow them to keep track of everything, despite rapidly increasing system complexity, and to make the right decisions based upon facts. The ESD department supports its customers during the entire development cycle from requirements to implementation.

■ Model-based Development

If we want to model not only software, but entire systems including the relevant non-functional properties, “off-the-shelf” products often do not suffice. When it comes to selecting, adapting, and combining suitable languages and tools, the experts of Fraunhofer IESE will provide comprehensive support for model-based development.

■ Architecture Development

The system architecture influences quality and development costs across system generations. Systematic processes in combination with automated, tool-supported architecture analyses and simulations make it possible to assess existing architectures and to identify and assess possible architecture variants early on. Architecture faults can thus be avoided proactively already during development.

■ Variation Management

Embedded systems are often not single products, but rather product families. They must be extensible and changeable throughout their lifetime. The strategic planning of system variants and modifications enables reuse rates of over 90%. Thus, system quality increases while costs and development times decrease. The ESD department supports its customers with efficient methods for variation management – from the initial potentials analysis to the introduction of customized solutions in the organization.



EMBEDDED SYSTEMS QUALITY ASSURANCE (ESQ)

To ensure product quality, a major portion of the development costs is invested into quality assurance. Complex systems, in particular, call for efficient methods that make high quality requirements achievable and reduce quality assurance costs at the same time. The ESQ department offers its customers cost-efficient methods that allow determining a system’s quality effectively and verifiably.

■ **Safety Engineering**

Fraunhofer IESE is one of the leading institutions in the area of functional safety. Our spectrum of services ranges from the introduction and implementation of all safety activities via hazard and risk analyses to safety cases. Process efficiency is particularly important in the development of software-intensive systems. By using innovative and largely automated processes, the IESE safety experts support their customers in developing even highly safety-critical systems efficiently.

■ **Model-based Testing**

Important keys to reducing costs include early performance and automation through tests. The test experts of IESE support their customers in performing model-based tests that employ automatically generated test cases to check the system already during early development phases. This saves not only costs and time, but also makes it possible to quantify the system’s quality and thus make quality statements that stand up to scrutiny.

■ **Static Analyses**

Efficient quality assurance is characterized by the fact that products are not only tested, but also checked with the help of static analyses. On the one hand, this means manual inspections; on the other hand, it implies automatic checking of source code or models. The ESQ department develops innovative, cost-efficient procedures and supports its customers in performing static analyses effectively.

Department Head

Sören Kemmann
 Phone +49 631 6800-2218
 Fax +49 631 6800-9 2218
soeren.kemmann@iese.fraunhofer.de



Sören Kemmann

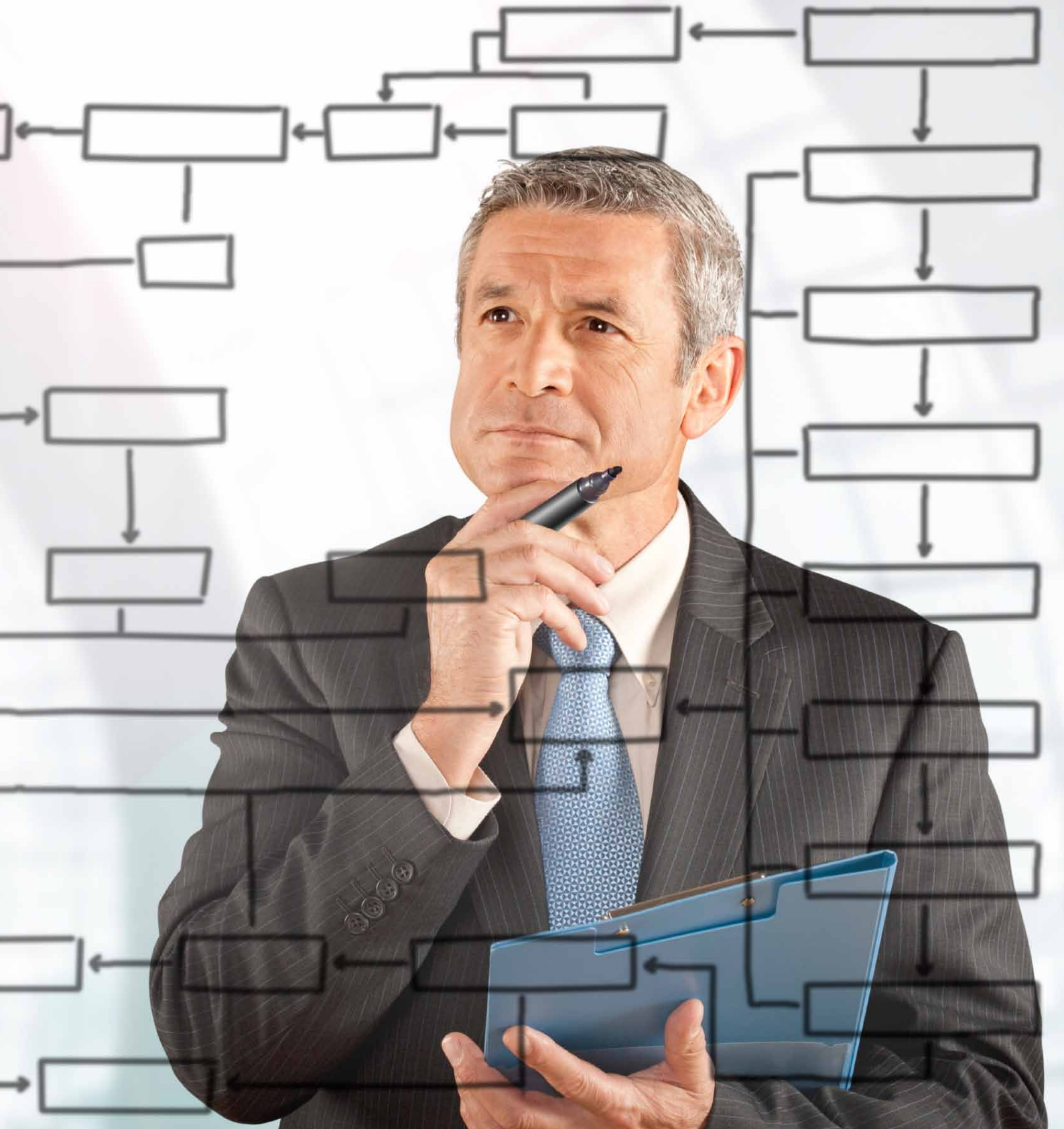

DIVISION PROCESS MANAGEMENT

Processes are the core of software and systems engineering. They are an important prerequisite for managing large software and IT projects and expedite the successful realization of software innovations. High product quality is the result of high-quality processes.

Mastering and improving processes is a great challenge. In order to achieve positive effects on products and business goals, processes must be goal-oriented, efficient, and verifiable, and must be based on solid experience. We support organizations in implementing domain-specific requirements on modern process management and in evaluating software-based innovations.

Goal-oriented measurement processes, customized process techniques, advanced prediction techniques, and technology evaluations are key parts of our service portfolio. The primary goal is to link processes and their intended effect. The benefit is a significant increase in the contributions of software and IT to an organization's business performance.

References

Ericsson uses the measurement approach GQM+Strategies® of Fraunhofer IESE to model the goals and strategies of a software development unit in an integrated manner and to control it with appropriate measurement systems. For this purpose, the approach was integrated into the goal specification process and adapted to the needs of Ericsson. The adaptation of the approach led to a more accurate specification of the goals and to integrated alignment of the goals and strategies on different levels of the organization. By systematically deriving an integrated measurement system, significant improvements could be achieved in terms of monitoring goal achievement and assessing the success or failure of a strategy. The transparent documentation of goals, strategies, and appropriate measurements also provided support for the effective communication of goals and strategies within the organization.

Software systems in the space industry are subject to special quality requirements – in a collaboration project with the Japanese space agency JAXA, Fraunhofer IESE is working on the definition of appropriate development processes. In addition, Fraunhofer IESE has produced a customized process model (SETG) of the relevant European ECSS Standards for Software Development and Software Management for the European Space Agency (ESA).

Division Head

Dr. Jens Heidrich
Phone +49 631 6800-2193
Fax +49 631 6800-9 2193
jens.heidrich@iese.fraunhofer.de



Dr. Jens Heidrich

Example Projects:

DEviSE	p. 78
Murex	p. 80
ZLB	p. 82
Multi-Touch	p. 84
IPA – Japan	p. 122
MUNDUS – EU	p. 124

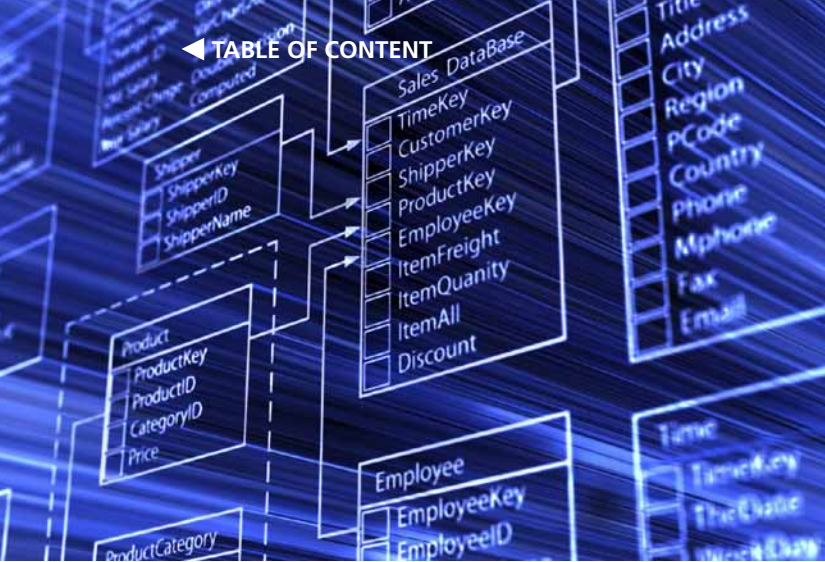

Department Head

Dr. Jens Heidrich
 Phone +49 631 6800-2193
 Fax +49 631 6800-9 2193
 jens.heidrich@iese.fraunhofer.de



Dr. Jens Heidrich

MEASUREMENT, PREDICTION AND EMPIRICISM (MPE)

In order to develop software-intensive systems and services that fulfill all given requirements and that are delivered on time and within budget, engineering-style processes are indispensable. This includes the definition and establishment of suitable measurement systems, measurement-based controlling and evaluation of products, processes, and techniques, as well as systematic use of data for prognoses and process optimization. The practice-oriented work of the department MPE focuses on the following core topics:

- **Measurement and IT/Business Alignment**
 We develop measurement systems and bring transparency to the development so that possible problems can be identified early on, risks can be minimized, and the quality of products and processes can be improved with lasting effects. We use measurement techniques to systematically align software and IT strategies with organizational goals and to achieve a clear value orientation of an organization's IT.
- **Cost and Effort Estimation as well as Sizing**
 We develop prognoses early on and determine the functional scope of software. This makes it easier to assess offers and project costs and to avoid project risks.
- **Quality Modeling and Defect Management**
 We develop customized quality models for evaluating software quality characteristics and establish integrated defect management.

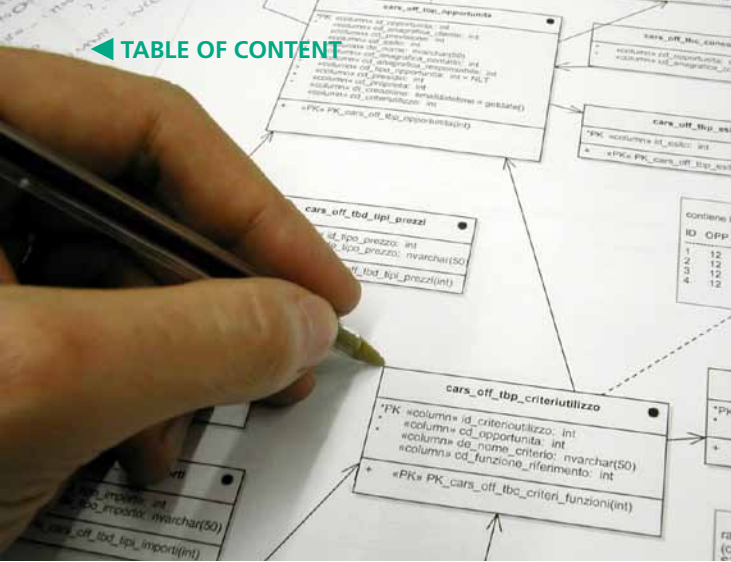

PROCESS COMPLIANCE AND IMPROVEMENT (PCI)

Processes are the driving force in the value chain of modern organizations. However, benefits can only be generated if processes are also accepted and lived. Thus, it is important to not only create process handbooks, but also to monitor the implementation and evolution of processes in daily practice. Furthermore, it must be possible to prove adherence to requirements on processes that have been accepted as binding requirements. The focus of the department PCI is on the following topics:

- **Modeling, Documentation, Evolution, and Introduction of Processes**
We support you in establishing lean, modifiable processes that are guaranteed to be compliant with relevant standards.
- **Process Analyses, Audits, Assessments, and Compliance Management**
Adherence to standards such as Automotive Spice or ITIL is required in many areas. We support you by performing gap analyses, help you to prepare for audits and assessments, teach special in-house training seminars, and assist you in fulfilling compliance requirements.
- **Evidence-based Process Improvement**
We offer you a simple starting point for reliably identifying improvement potential in your processes and for continually optimizing your processes, with special emphasis on the evaluation of process performance and on the ROI of improvement measures.

Department Head

Rolf Hendrik van Lengen
Phone +49 631 6800-2103
Fax +49 631 6800-9 2103
rolf.van.lengen@iese.fraunhofer.de



Rolf Hendrik van Lengen



DIVISION INFORMATION SYSTEMS

Modern information systems and interactive systems are becoming ever more complex. Hype topics such as service orientation or cloud computing as well as increasingly mature technologies including those in the area of mobile end devices further increase the complexity of these systems. The challenges that our customers often face are the result of multi-dimensional project settings with many stakeholders, interests, and systems as well as the complex workflows of one or several networked companies. Other typical challenges include complex user interfaces, ensuring and verifying required system qualities, and last but not least, the multitude of variants and configurations of our customers' systems.

The division Information Systems develops innovative methods and solutions for the development of complex information systems and interactive systems. In order to offer an immediate added value, we apply our methods directly during our customers' product development and/or transfer our methods and solutions to our customers. These include organizations that use software solutions for their business processes, e.g., from the banking and insurance sector or from the domain of medical IT systems, organizations from such areas as public administration and defense, as well as software developing companies (both large corporations and SMEs).

Division Head

Dr. Jörg Dörr
Phone +49 631 6800-1601
Fax +49 631 6800-9 1601
joerg.doerr@iese.fraunhofer.de



Dr. Jörg Dörr

Example Projects:

John Deere	p. 86
Accenture CAS	p. 88
DESY	p. 90
Insiders	p. 92
automotiveHMI	p. 94
P23R	p. 96
Attract	p. 98
Software Cluster	p. 100
FibuNet	p. 102
MUNDUS – EU	p. 124

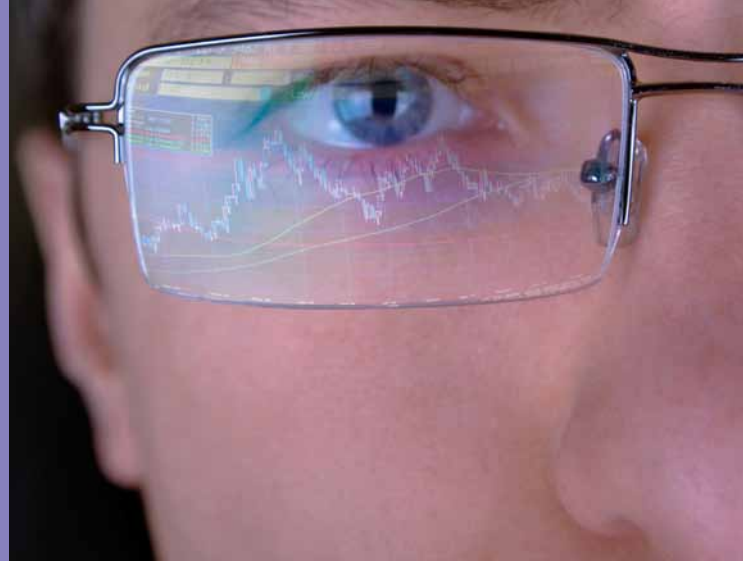

Department Head

Dr. Marcus Trapp
 Phone +49 631 6800-2186
 Fax +49 631 6800-9 2186
 marcus.trapp@iese.fraunhofer.de



Dr. Marcus Trapp

INFORMATION SYSTEMS DEVELOPMENT (ISD)

We address challenges arising during development early and continuously with the help of constructive, innovative development approaches and methods, from requirements elicitation via architecture to design. Our strength lies in examining the non-functional (quality) requirements, which are hard to capture and often affect the entire system. Clearly defined software development artifacts with clearly defined levels of abstraction allow focusing on what is really important and interlink with both traditional and agile process models.

■ Requirements Engineering

With our renowned requirements approach Fraunhofer Satisfy, which is custom-tailored to your requirements, we integrate requirements engineering and constructive usability in the context of modern information systems, addressing issues such as lean and agile development, user-centered and innovative software, standard-compliant procurement (especially in eGovernment), as well as organization-wide business process management (BPM). The approach offers traceability throughout and minimal documentation of the necessary requirements decisions, and hence adds value to a project right from the start.

■ User Experience for Business Applications

With our proven methods we support you in developing systems that not only support their users, but also allow having a positive User Experience. This has been proven to contribute to the achievement of your business goals.

■ Architecture-Centric Engineering

With our successful Fraunhofer ACES approach, we support you in defining and evaluating architectures for complex information systems. The iterative, scenario-based process allows you to master the complexity of architecture definition and migration and to make reliable predictions regarding critical features of the system early on.

■ Product Line Engineering

Our successful approach Fraunhofer PuLSE™ supports you in establishing, developing, and managing a software product line as well as in analyzing and improving your already existing configuration infrastructure for variant-rich information systems.

■ Business Goes Mobile

With our approach GoMobile we help you to exactly identify those areas where a mobile app makes sense as support for your business processes. We can also develop a prototype that can be executed on various mobile devices to help you make your decisions.



INFORMATION SYSTEMS QUALITY ASSURANCE (ISQ)

In addition to the constructive activities needed to achieve the required product quality, efficient and effective methods are needed for quality assurance. The department ISQ offers its customers cost-efficient methods for validating the required system quality. One special focus is on the quality of security, which is becoming increasingly important for networked information systems.

■ Integrated Testing

Many projects expend more effort on testing activities than necessary. Fraunhofer IESE focuses testing effort by aligning and integrating testing activities with preceding software development activities such as requirements analysis, but also with inspections. Our support includes training and technology transfer, evaluation of existing testing processes, support during testing, and test case derivation.

■ Tool-supported Inspections

Defects that remain undetected until the testing phase cause unnecessary costs. Inspections permit performing quality assurance of your documents early in the software development cycle. We support our customers' inspectors by using the Fraunhofer tool DETECT to perform efficient manual evaluation of your development documents. DETECT offers suitable reading support, can be customized to individual quality features, and teaches the inspectors expert knowledge. Last but not least, DETECT generates clearly structured defect reports.

■ Security Audits and Definition of Security Concepts

Security gaps in IT systems can cause serious damages and the ensuing loss of trust can negatively affect business success. We support our customers in determining their security requirements regarding pertinent guidelines and standards. For our customers' projects, we define security concepts for infrastructure and software or perform tool-supported assessments of existing systems and concepts in terms of relevant security requirements and standard compliance.

■ Usage Control for Distributed Data

To protect private users or company-related information from data misuse, e.g., in the form of identify theft, disclosure of strategic business data, and image loss due to privacy violations, simple forms of access control are no longer sufficient. Fraunhofer IESE therefore relies on innovative mechanisms for data usage control. By using predefined policies for data usage and modifications to the used and involved IT systems, it can be monitored and ensured that the data can only be used in accordance with rules (so-called policies) that have been specified by you.

Department Head

Michael Eisenbarth
 Phone +49 631 6800-2181
 Fax +49 631 6800-9 2181
michael.eisenbarth@iese.fraunhofer.de



Michael Eisenbarth



PROJECTS

A large number of third-party funded projects with industry for transferring innovative methods into practice and publicly funded projects for establishing new competencies are characteristic of the application orientation of Fraunhofer institutes. With all three of its divisions, Fraunhofer IESE has established itself as a strategic and dependable partner both in public programs and in major industries.

In the public sector, Fraunhofer IESE plays a leading role in important major projects. In the area of Embedded Systems, these include the BMBF project SPES2020 on the development of a platform for the model-based development of embedded systems as well as ARAMiS on the development of multi-core-based software solutions. In the area of Information Systems, the Software-Cluster “Software Innovations for the Digital Enterprise” aimed at the development of interoperable, adaptive, and secure software in support of business processes is the main focus. In these public projects, we are also collaborating closely with industry partners. Beyond that, the Fraunhofer-Gesellschaft is investing internal funds to establish competencies in the area of data security (Attract), while continuing its commitment in the areas of commercial vehicles (Innovation Cluster DNT) and acceleration of know-how transfer from the University of Kaiserslautern to Fraunhofer IESE (Innovation Center Applied System Modeling).

Direct industry projects exist with leading companies in Germany’s major industries. Examples include Audi in the automotive sector, John Deere in the area of commercial vehicles, Accenture CAS in the area of software, and FibuNet in the area of information systems. Projects with small and medium-sized enterprises (such as Eckert & Ziegler AG, KSB AG, and Insiders Technologies GmbH) are another focal point of our work. Our commitments abroad are steadily growing as well (e.g., IPA/SEC in Japan, Murex in France, UEPB in Brazil). Another special focus is on collaboration projects in Brazil in the area of medical devices as well as on collaboration projects in Australia in the area of logistics.

JOHN DEERE: Operator in the Loop	68
ECKERT & ZIEGLER: Future Trends for Safety and Usability in Radiation Therapy	70
KSB: Establishment of a Future-Proof and Sustainable Software Architecture	72
SPES 2020 – Functional Safety in the Model-Based Development of Embedded Systems	74
ARAMiS – Automotive, Railway and Avionics Multicore Systems	76
DEViSE – Dynamic Identification, Extraction and Reuse of Components in Distributed Software Development	78
MUREX: Sustaining Success through Business Alignment, Goal-Oriented Measurement, and Best Practice-Based Software Process Improvement	80
ZLB – Central State-Wide Treatment Capacity Indicator in Rhineland-Palatinate	82
MULTI – Multi-Touch Interaction for Smart Homes, Energy Management und (Virtual) Museums	84
JOHN DEERE: Design and Prototype Implementation of a Mobile Task Management Solution	86
ACCENTURE CAS: Methodological Support for the Architecture Definition of the New Mobile Platform	88
DESY: Business-Process-Oriented IT Solutions at Deutsches Elektronen-Synchrotron	90
INSIDERS TECHNOLOGIES: Positive User Experience – Interaction Design	92
automotiveHMI – Optimized HMI Development in the Automotive Industry	94
P23R Prozess-Daten-Beschleuniger: Simple, Safe and Efficient Fulfillment of Information Obligations	96
ATTRACT – Security for Distributed Data	98
SOFTWARE CLUSTER: Enforcement of Security Policies across Corporate Boundaries	100
FIBUNET: Keeping the Figures under Control through Continuous Modernization	102

JOHN DEERE: Operator in the Loop

Contact

Bastian Zimmer
 Phone +49 631 6800-2114
 Fax +49 631 6800-9 2114
bastian.zimmer@iese.fraunhofer.de



Bastian Zimmer

Collaboration Partner

John Deere
www.deere.com



JOHN DEERE

University of Illinois at
 Urbana-Champaign
<http://illinois.edu/>

Safety First

Providing distributed functions in a network. Adaptive. Automated. Multifunctional. According to the German National Academy of Science and Engineering (www.acatech.de), all of these are central technical properties of cyber-physical systems, a category of embedded systems that will become increasingly important in the near future. Many of the core properties of a cyber-physical system are already fulfilled by the technology Tractor Implement Automation (TIA), which was developed by John Deere.

TIA allows an agricultural implement such as a baling press to control central parameters of a tractor, such as speed, steering, or the power take-off. This makes it possible to automate workflows and optimize a multitude of agricultural technology processes. The technological basis of TIA is the standardized data bus ISOBUS, which provides the framework for the flexible coupling of agricultural implements from different manufacturers, which would offer the greatest possible benefit to the customer.

However, such an “open” design of a system would entail exorbitant costs, caused primarily by the challenge to ensure functional safety in all conceivable cases. Currently, John Deere is investigating every possible combination of tractor and implement very carefully and thoroughly in order to guarantee the safety of the system with the highest priority. By opening the system, the number of possible tractor-implement combinations would skyrocket though, and as a consequence, the costs for safe development would also rise enormously. This is the reason why the TIA technology is currently only available to selected implement manufacturers.

The Role of the Operator

In the context of our collaboration, different system designs were developed and evaluated that allow incorporating the operator into the safety concept of the software-controlled functions. By integrating the human operator, his flexible perception and problem-solving skills can be used to complement the electronic systems. In safety-relevant industries such as aviation or rail technology, this has been standard practice for many years already. We hope that the re-orientation of the safety concept will provide increased flexibility, which is then expected to be able to deal with the special features of the TIA technology.

There exist numerous possibilities for including the human operator in a safety concept, especially considering a technology such as TIA that can be used in so many different ways. In order to cover at least a large number of conceivable use cases, the following classification is used for describing the different roles of the operator in the safety concept:



- The operator detects failures and risks
- The operator controls failures and risks
- The operator acts as redundancy (combination of the other roles)

Development and Evaluation of Design Alternatives

Each of these roles has different requirements on both the human and the system. In order to fulfill these requirements, several alternative system designs have been developed. Each of these designs was constructed as an individual modification of the Simplex architecture – a safety concept developed at the University of Illinois at Urbana-Champaign (UIUC).

These designs were then analyzed both in terms of functional safety and in terms of their productivity. For the analysis of functional safety, the model-based technique of component-integrated component fault trees (C²FT) developed at Fraunhofer IESE was used. The evaluation of productivity was done by assessing the negative impact of the safety function on the automated process (e.g., shut-downs).

In order to assess the frequency and the extent of damage of the negative impact, probabilistic methods were used. Each design alternative was evaluated in terms of different usage scenarios of the system (e.g., low load, high load) and different parameterizations of the safety function (rare weak intervention to frequent strong intervention). This allowed evaluating the alternative system designs with regard to their suitability in various TIA applications.

For 2012, a follow-up project is planned that will build on the lessons learned.

Further Reading:

Business Area Automotive and
Transportation Systems p. 40
Division Embedded Systems p. 55

ECKERT & ZIEGLER: Future Trends for Safety and Usability in Radiation Therapy

Contact

Sören Kemmann
Phone +49 631 6800-2218
Fax +49 631 6800-9 2218

soeren.kemmann@iese.fraunhofer.de



Sören Kemmann

Collaboration Partner

Eckert & Ziegler AG
www.ezag.com

The Eckert & Ziegler Group is one of the largest manufacturers worldwide of radioactive components for medical, scientific, and metrological purposes. The company focuses on applications in cancer therapy, industrial radiometry, and nuclear medicine diagnostics, as well as on disposal of low to medium-intensity radioactive waste.

The early identification of future potential is the mission of Fraunhofer IESE. Consistently pursuing visionary roadmaps and preparing early for future challenges and opportunities through close coupling of science and industry contribute to ensuring a technological edge. Unique selling points in the area of radiation therapy include making software flexible and safely mastering complexity while offering maximum interoperability.

Application

Standards such as IEC 62366 and 62304 call for detailed analyses regarding purpose, context, user, and tasks in the context of developing software as a medical product in order to ensure a stable basis for follow-up activities such as architecture design and risk management. However, the industrial context of the future is already demanding technologies today that go beyond what is written in standards. In order to be prepared for the future, one must already know today how to develop safe and ergonomic systems under the constraints of the near future.

Safety Concept

Methods for the derivation of safety concepts in accordance with ISO 14971 are generally well suited for identifying hazards and safety goals of system requirements. Matters become interesting, however, once qualities such as interoperability increasingly come into play in future software systems. With the innovative methods of Fraunhofer IESE, Eckert & Ziegler is now ready to master software systems with high complexity and high criticality in a future-proof way. In the context of risk management, analysis methods on the basis of fault trees on the system and software architecture level allow efficient identification of causes and potential countermeasures even in situations where traditional methods reach their limits.



Usability

Ever since the introduction of IEC 62366, the demand for ergonomic device development has been part of the basic portfolio of anyone involved with software in the medical area. Particularly in radiation therapy, the optimal interplay between human and machine is a matter of life and death. The expectations regarding human-machine designs that come with this special responsibility have become ever more important in the past and will also continue to grow in the near future. No wonder then that Eckert & Ziegler AG is not afraid of assigning top priority to the usability process nor of preparing for upcoming trends together with Fraunhofer IESE.

Model-based Development

Model-based techniques are not immune to rapid technological evolution. Modern modeling techniques, analysis methods, and tools for the development of complex system and software architectures are the subjects of scientific investigation and evolution by Fraunhofer IESE. In cooperation with Eckert & Ziegler AG, processes that are optimized for the area of nuclear medicine could be identified and applied.

Manufacturing plant for the production of low-intensity radioactive implants for prostate cancer

Further Reading:

Business Area Medical Devices p. 44

Division Embedded Systems p. 55

KSB: Establishment of a Future-Proof and Sustainable Software Architecture

Contact

Dr. Jens Knodel
 Phone +49 631 6800-2168
 Fax +49 631 6800-9 2168
jens.knodel@iese.fraunhofer.de



Dr. Jens Knodel

Pumps transport a medium from one place to another. However, what sounds like a simple product at first constitutes a challenge for the sales representatives of KSB Aktiengesellschaft: Product groups such as pumps, mixers, fittings, valve actuators, pump automation, and systems such as pressure booster systems with features such as application domain, pumped medium, pumped quantity, operating temperature, pumping height, RPM, motor, seals, pipes, connectors, etc. occupy an enormous range of variants, already comprising more than 15 million different marketable combinations today. In order to master this complexity and provide the best possible product selection support to its customers and sales representatives, KSB Aktiengesellschaft has developed a product configurator and a web shop for its sales. For more than five years, this system has been supporting users in selecting optimal product configurations, taking into account the respective purpose the product is to be used for. Included are functions from creating offers all the way to the transfer of data to construction and production.

In the future, KSB Aktiengesellschaft wants to continue to support the envisioned growth goals and its internal workflows regarding the sale of products with the help of software systems adequately, efficiently, and in a modern way, and has decided to rely on the competencies of Fraunhofer IESE to do so.

- In close cooperation with the team of KSB AG, Fraunhofer IESE defines and models the next-generation software architecture in order to implement the strategic requirements and the qualities demanded of the systems. In addition to documentation of the decisions, definition of the building plan, and integration into the application landscape, training is also provided on how to use the architecture for planning and monitoring development and controlling the success of the development.
- Feasibility studies and joint prototypes provide reliable information about the sustainability and scalability of new concepts. As an objective partner, Fraunhofer IESE points out benefits, drawbacks, and risks.
- Information about the current software is provided by our tool Fraunhofer SAVE (Software Architecture Evaluation and Visualization), which visualizes dependencies and also allows checking whether the actual architecture matches the planned architecture.
- As a neutral instance, Fraunhofer IESE accompanies the market research and technical suitability assessment of different configurator manufacturers whose technologies are candidates for inclusion in the future system landscape.
- Modern applications also call for modern interaction concepts. Fraunhofer IESE demonstrates with the help of interaction prototypes what the optimization of the user interfaces looks like for the respective user group.

Collaboration Partner

KSB Aktiengesellschaft
www.ksb.com



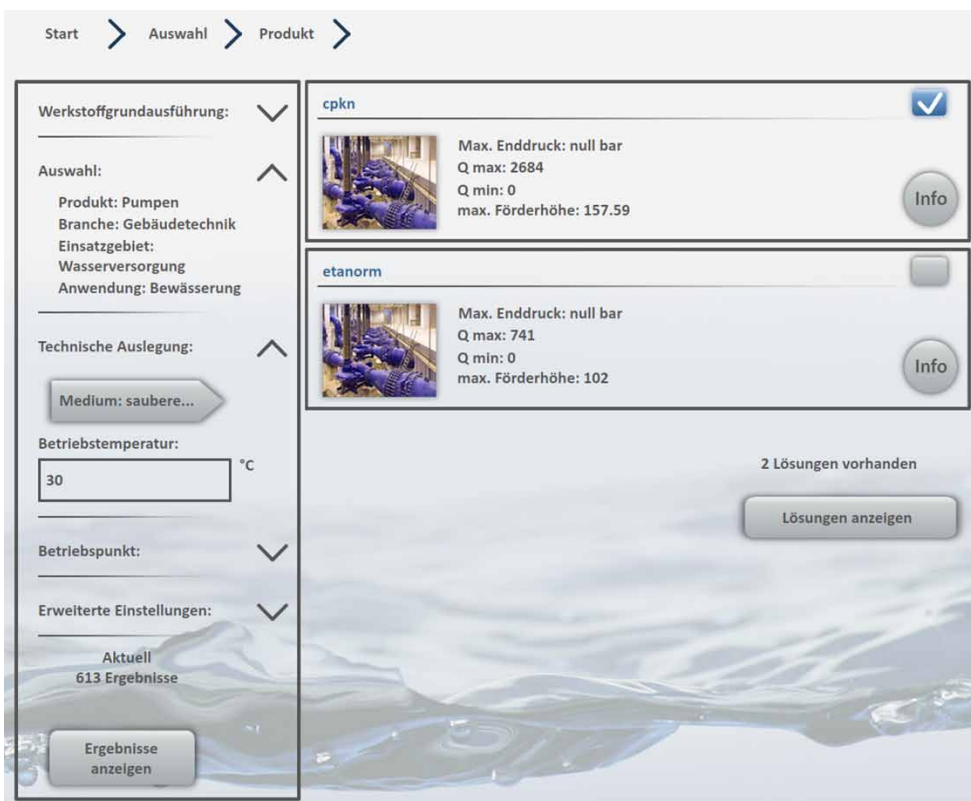
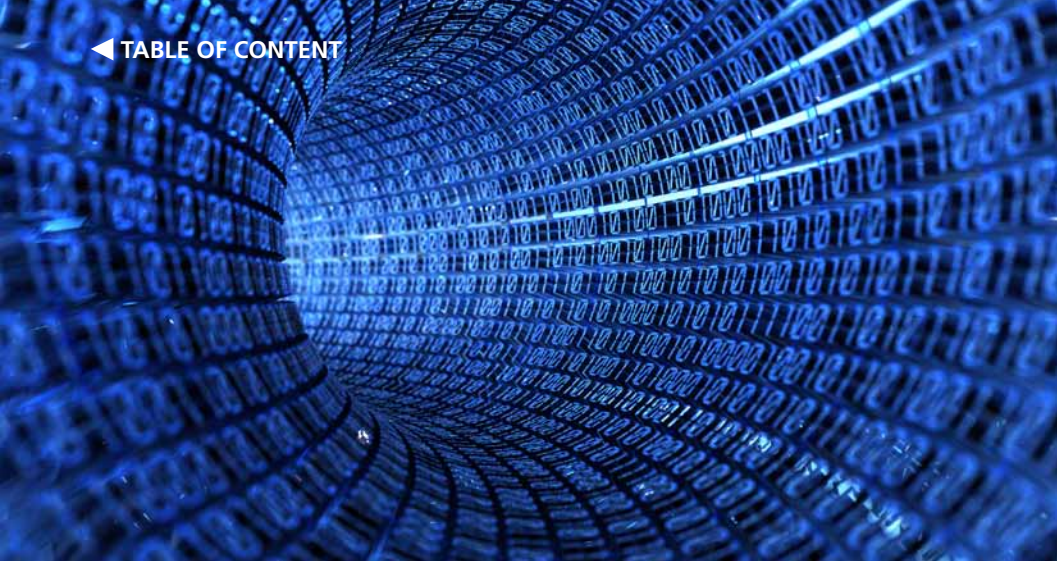

Screenshot of the interaction prototype:
A click prototype illustrates what novel types of interaction concepts may look like.

Software architectures whose design has been engineered sustainably ensure success in software and systems development – which is why KSB AG is continuing its collaboration with Fraunhofer IESE.

“Our collaboration with Fraunhofer IESE has turned out to be a good decision. The analysis of our current system, the development of a future-proof software architecture, sustainable design decisions, the execution of prototypes, and the introduction of a modern holistic development methodology have always been accompanied by a high degree of professional competence, flexibility, and extraordinary commitment. We thank you for the open, pleasant, and very trusting collaboration and would like to continue it successfully with you in 2012.”

Holger Eser, T-CF161, KSB Aktiengesellschaft

Further Reading:

- Business Area Automation and Plant Engineering p. 42
- Division Embedded Systems p. 55

SPES 2020 – Functional Safety in the Model-Based Development of Embedded Systems

Contact

Dr. Mario Trapp
 Phone +49 631 6800-2272
 Fax +49 631 6800-9 2272
mario.trapp@iese.fraunhofer.de



Dr. Mario Trapp

Functional safety is one of the most important quality properties for modern embedded systems. Whereas model-based methods and processes for the development of such systems have recently established themselves on the market and allow mastering the ever larger and rapidly increasing complexity of safety-critical embedded systems, the development of established methods and tools in the area of functional safety has been stagnating. It was therefore an important aspect of the BMBF project Software Platform Embedded Systems (SPES) 2020 to close this gap with methods and tools that can actually be used in industry. To this end, the proven concepts of model-based development were seamlessly integrated with the models and methods of functional safety analysis. During the project's runtime, three crucial core contributions were made in this context:

- Established safety models could be integrated completely into the development artifacts of model-based safety-critical systems.
- Building on the combination of functional safety analysis models and development models, the integration of additional quality properties could be demonstrated, such as the execution time of embedded systems through real-time guarantees.
- In order to ensure the functional safety of embedded systems even during vertical development steps, an automated process was developed for integrating safety-critical embedded systems software into hardware platforms in a safety-optimal way.

Further Information

Project Homepage
www.spes2020.de



Software Plattform Embedded Systems 2020

The illustration shows four components of an embedded system, identifiable by the label *block*, and two so-called component fault trees, identifiable by the label *CFT*. With the help of a tool developed in SPES2020, safety analyses can now be performed not only with monolithic and correspondingly complex analysis models. Instead, this complexity is distributed to smaller analysis models associated with a system's components. By integrating such component-based fault tree models, the elements of functional safety analysis could be associated with single components. This procedure was used in the SPES2020 project not only for safety analyses, but also for a probabilistic examination of time barriers and for the functionally safe integration of software components into hardware components.

FUNDED BY



Bundesministerium
 für Bildung
 und Forschung

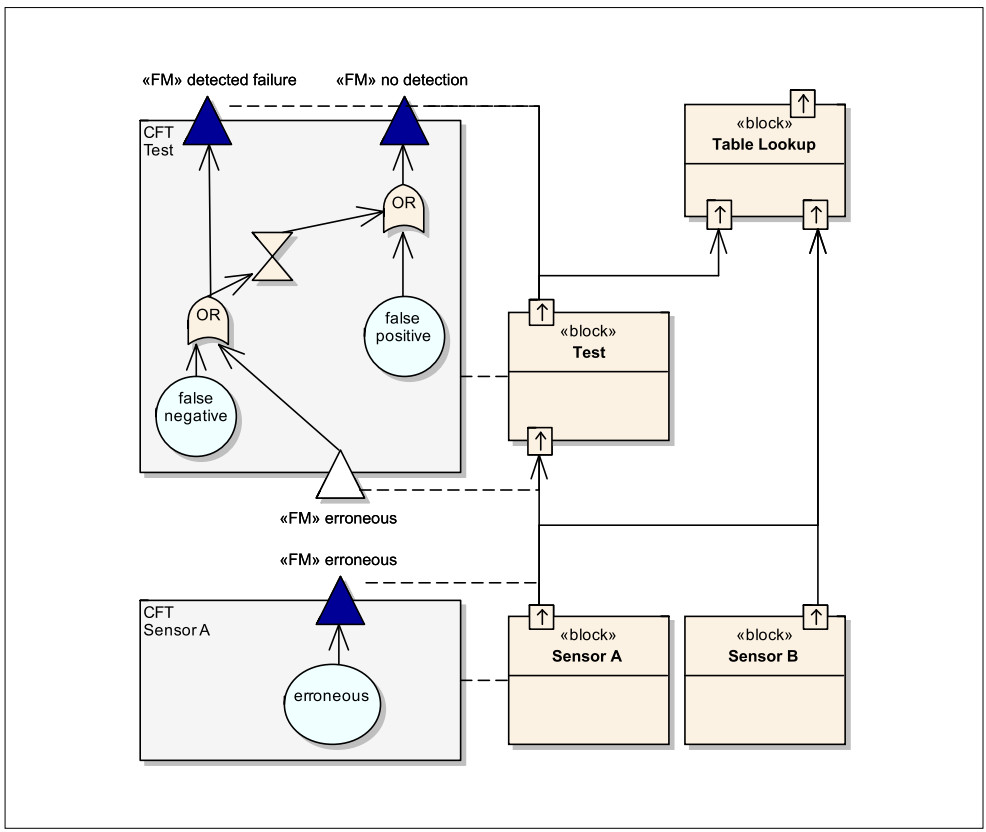
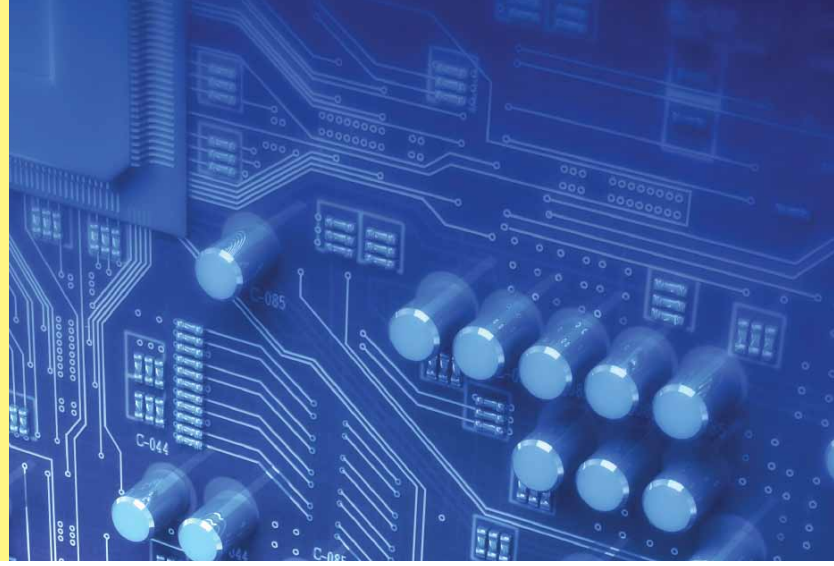
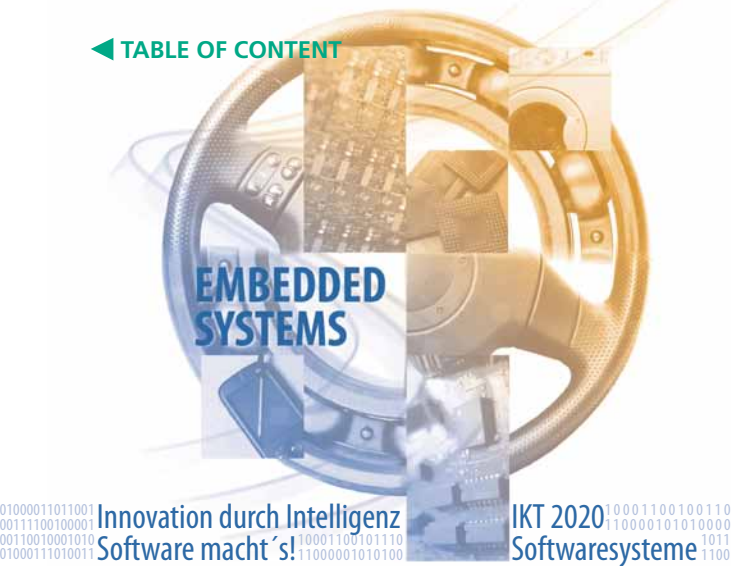

SysML model of an embedded system and integrated component fault tree model

Empirical studies were performed to test the efficiency of this component-based method with regard to the objectives, such as better mastery of complexity. These studies were initially done with advanced users, then with avionics experts. The results show that the component-based method offers major advantages over a traditional method, in particular in terms of consistency, change maintenance, and clarity of the models. This effect can be seen both among the advanced users and among the experienced experts.

Collaboration Partners

See Project Homepage
<http://spes2020.informatik.tu-muenchen.de/partner.html>

Further Reading:
 Business Area Automotive and Transportation Systems p. 40
 Division Embedded Systems p. 55

ARAMiS – Automotive, Railway and Avionics Multicore Systems

Contact

Dr. Mario Trapp
 Phone +49 631 6800-2272
 Fax +49 631 6800-9 2272
mario.trapp@iese.fraunhofer.de



Dr. Mario Trapp

Already today, embedded systems are highly important for our society and for business. The ever greater function scope, the strong networking of the systems, and new generations of systems such as cyber-physical systems necessitate higher performance of these systems. To date, primarily single-core processors have been used in embedded systems. However, the computing power we need today and will need in the future can no longer be achieved simply by increasing the clock rate of single cores. The high power dissipation alone would generate too much heat, to name but one of many reasons. Industry is getting ready to work with hardware platforms in which several processor cores are used (multi-core). Whereas multi-core systems are already the current standard in classical IT systems, these concepts cannot be easily transferred to embedded systems. Using them in embedded systems requires that indispensable properties such as real-time, safety, security, reliability, or energy consumption are ensured. The existing hardware architectures used in classical IT systems are unable to guarantee these quality properties. The resulting dilemma can be seen very clearly in avionics: On the one hand, only multi-core systems will be available in the future for hardware platforms. However, since many quality aspects such as, in particular, the time behavior of existing multi-core systems cannot be proven sufficiently, certification bodies are nowadays refusing to license airplanes based on multi-core technologies. Although more than 90% of all processors are used for embedded systems today, cases where multi-core systems – a technology of the future – can be used for embedded systems are very rare.

Further Information

Project Homepage
www.projekt-aramis.de

This is the reason why the goal of the research project ARAMiS (Automotive, Railway and Avionics Multicore Systems) is to develop multi-core-based solutions for the mobility domains automotive, railway, and avionics that will demonstrably fulfill all necessary quality properties needed to be licensed by certification bodies. The project ARAMiS was launched as the first project of the “Agenda Cyber-Physical Systems” of the German Federal Government on 01 December 2011. It has a volume of about 40 million euros and will run for three years. Fraunhofer IESE and Sysgo AG are in charge of the sub-project “Software”, which is the largest sub-project of ARAMiS with almost 30 partners and a total effort of more than 76 person-years.

ARAMiS

FUNDED BY



Bundesministerium
 für Bildung
 und Forschung

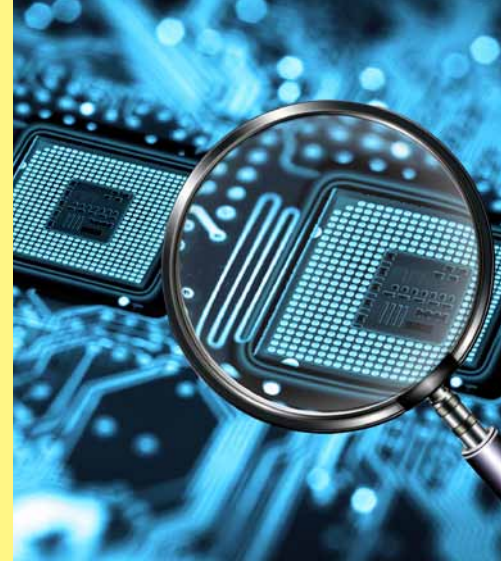

In terms of content, Fraunhofer IESE will be mainly responsible for defining concepts for ensuring safety and for providing the respective safety cases for the solutions developed in the project. Since the certifiability of the developed solutions and the requisite safety assurance are a central goal of the project, the fact that the institute was awarded this task once again underlines the institute's reputation as a competence center for functional safety.

Furthermore, Fraunhofer IESE will play a major role in the systematic evaluation of the methods, techniques, and tools developed in ARAMiS. Evaluation will take place in the context of four large-scale case studies. Here, in addition to merely answering the question of feasibility, the aim is to investigate whether or not the developments satisfy the quality requirements.

Collaboration Partners

See Project Homepage
www.projekt-aramis.de

Further Reading:

Business Area Automotive and
Transportation Systems p. 40
Division Embedded Systems p. 55

DEviSE – Dynamic Identification, Extraction and Reuse of Components in Distributed Software Development

Contact

Axel Wickenkamp
 Phone +49 631 6800-2155
 Fax +49 631 6800-9 2155
axel.wickenkamp@iese.fraunhofer.de



Axel Wickenkamp

Further Information

Project Homepage
www.kmu-devise.de

Despite all progress made in software engineering, the development and maintenance of software is still cumbersome and error-prone. Particularly when distributed groups are involved, e.g., teams of developers in different locations, it is a challenge to ensure high program quality and future extensibility and adaptability. Here, the reuse of program code plays an essential role. The wheel is not continually re-invented; rather, existing program logic is adapted and used in other projects. However, this also entails risks if reuse is sloppy, documented badly, and not traceable.

The joint research project DEviSE (Dynamic Identification, Extraction and Reuse of Components in Distributed Software Development) resolves this dilemma by developing methods and tools that analyze existing source code semi-automatically and identify parts that are suitable for reuse. In doing so, code quality and known pitfalls in the program logic are identified and taken into account. These software components are extracted semi-automatically, are adapted for reuse, and are stored in an easily accessible way. Since the reuse of software components is ensured in a qualitative manner, the productivity of the developers as well as the quality and maintenance of the source code can be increased tremendously in distributed software development. In addition, DEviSE will also generate improvement suggestions for increasing quality. In the context of this project, a comprehensive reuse repository is being designed and tested in the context of exemplary industrial applications. Extensive search functions support a programmer during the extension or new development of program functionality, while suggestions regarding reuse are made to him at the same time on the basis of the content of the repository. This also facilitates the reuse of software components, especially in distributed teams with longer communication channels.



Thus, DEviSE provides an increase in efficiency and facilitates programming, while also offering improved program quality and easier software maintenance – which adds up to a relevant competitive edge for the target group of German SMEs (small and medium-sized enterprises).

FUNDED BY



Bundesministerium
 für Bildung
 und Forschung

Grant number: 01IS0013D



```

// #pragma once > 1000
#endif // MSC_VER > 1000
#ifndef AFXWIN_H
#error include "afxwin.h" before including this file
#endif
#include "resource.h" // icons, menus, etc.
// CDMotionApp:
// See DMotion.cpp for the implementation of the class
class CDMotionApp : public CWinApp
{
public:
    CDMotionApp();
// Overrides
// ClassWizard generated virtual function overrides
//{{AFX_VIRTUAL(CDMotionApp)
public:
    virtual BOOL InitInstance();
//}}AFX_VIRTUAL

// Implementation
//{{AFX_MSG(CDMotionApp)
afx_msg void OnAppAbout();
// NOTE - the ClassWizard will add and remove
// MSG HANDLERS here.

```

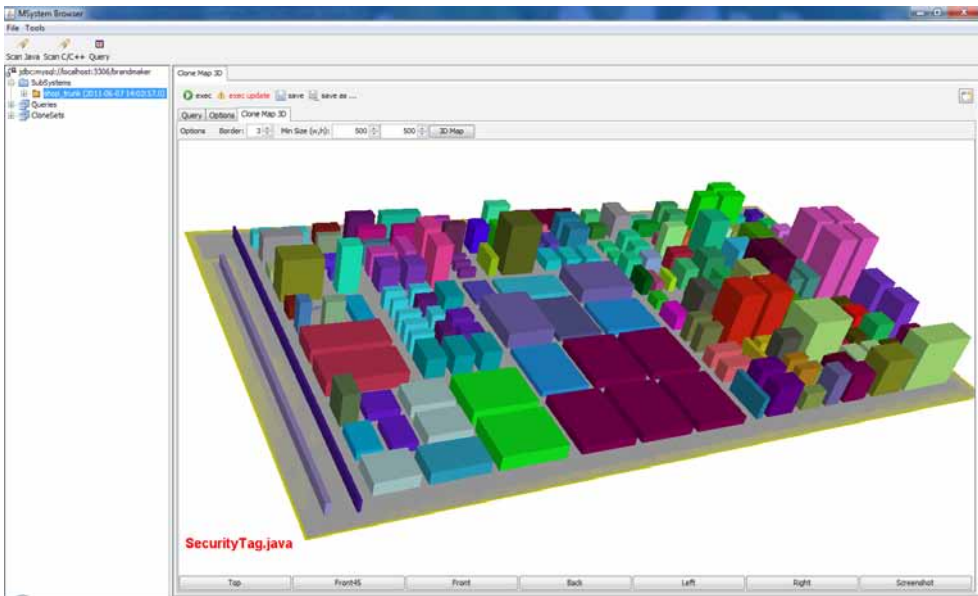

The Fraunhofer M-System allows performing a detailed analysis of component dependencies on the basis of a static code analysis. At the bottom of the figure, software clones and their distribution in the system are illustrated by means of a 3D tree map.

The contributions of Fraunhofer IESE to this project consist of its many years of experience in the areas of software reuse and metric-based definition of quality models. The central component is the development of a quality model for evaluating program parts regarding their suitability as components (extraction potential) and for ensuring the quality of the reuse repository. The tool M-System, which was developed at Fraunhofer IESE, is used as a basis. In addition, context-dependent search functions are made available in the repository in order to identify suitable, high-quality components and integrate them semi-automatically into existing code structures.

Collaboration Partners

Acellere GmbH
www.acellere.de

BrandMaker GmbH
www.brandmaker.com

FZI Forschungszentrum Informatik
www.fzi.de

Further Reading:
 Business Area Information Systems p. 46
 Division Process Management p. 59

MUREX: Sustaining Success through Business Alignment, Goal-Oriented Measurement, and Best Practice-Based Software Process Improvement

Contact

Dr. Adam Trendowicz
 Phone +49 631 6800-2193
 Fax +49 631 6800-9 2193
adam.trendowicz@iese.fraunhofer.de



Dr. Adam Trendowicz

Michael Ochs
 Phone +49 631 6800-1604
 Fax +49 631 6800-9 1604
michael.ochs@iese.fraunhofer.de



Michael Ochs

Nowadays, many organizations and businesses rely on software-based systems and services. IT and software are becoming central drivers for innovation and growth in an organization. New innovation and business success increasingly depend on software and IT. This is true in all business domains that rely partially or heavily on software-based solutions.

One typical domain that heavily uses software-based solutions is investment banking. Software for trading, risk management, and processing is exposed to specific reliability and performance requirements from end users such as traders, risk managers, fund managers, etc. Murex S.A.S., located in Paris, France, our partner in this collaboration, is one of the world's leading solution providers for trading, risk management, and processing solutions, providing constant innovation to its customers. Murex S.A.S. has recently and repeatedly been rated Overall #1 Top Technology Vendor in the Risk Technology Rankings 2011 by Risk magazine.

In order to further remain on the leading edge on both the business / technical side and the technological and software production side, it is important to ensure (1) even stronger alignment of related strategies with the business goals of the organization, and (2) effective implementation of the strategies through best-practice software development and IT-service practices. The alignment of IT and software with business goals includes the systematic derivation of IT and software strategies from an organization's higher-level goals on the one hand, and clearly demonstrating the contribution of existing IT and software strategies towards business success on the other hand. Measurement provides the necessary means for evaluating the success of the defined strategies and the achievement of related goals, thus demonstrating the contribution of software and IT to an organization's business value.

Yet, aligning IT- and software-related strategies with business goals alone does not guarantee organizational success. Strategies must be effectively implemented. For this purpose, development processes based on industry best practices have to be introduced and followed.

The objectives of the collaboration with Murex S.A.S. were (1) to identify business-driven software improvement goals and specify key performance indicators for monitoring the contributions of software development and (2) to improve software processes based on best practices.

Business Alignment and Goal-oriented Measurement

In order to identify business-driven software improvement goals and specify relevant key performance indicators (KPIs), Fraunhofer IESE introduced the GQM+Strategies® approach at Murex



S.A.S. and supported key stakeholders from business and technical units at Murex S.A.S. in applying the approach to their problem context. The approach supports the definition and alignment of goals and strategies among the different stakeholders and supports them in deriving key performance indicators for evaluating the success of strategies and achievement of goals.

Collaboration Partner

Murex S.A.S.
www.murex.com

The new KPI system now serves as a starting point for monitoring, controlling, and improving software development so that it can best support the achievement of the business objectives of Murex S.A.S. The data collected and analyzed in the pilot application are used as a baseline for controlling future software development projects and deriving potential improvements to software development strategies.

Best Practice-based Software Process Improvement

In order to improve the existing software processes at Murex S.A.S., a first process capability baseline was identified. This was accomplished by conducting a process review as a series of interviews with relevant stakeholders and responsible staff members focusing on different aspects of software maintenance activities and projects within Murex S.A.S. The focus of the initial capability baseline was on the disciplines Project Management, Software Construction (from Requirements Engineering to the Build of the Product), and Quality Assurance. The review compared the practices found and conducted at Murex S.A.S. to an international and commonly agreed best practice standard (CMMI® for Development). The baseline as a result of this review gives a detailed external and objective, fact-based view on the strengths and improvement opportunities found in the operative software maintenance processes under review.

Relying on this initial baseline, a set of improvement actions was identified, defined, prioritized, and brought into a roadmap. The implementation of the improvement actions has also been started recently according to this roadmap, and will be continued using the roadmap as a master plan.

Jean-Pierre DACHER, COO of Murex S.A.S. and Head of Software Engineering, on the collaboration with Fraunhofer IESE: *“The collaboration helped us to formulate action plans that both align with our business objectives and industry best practices. A critical ingredient for success was Fraunhofer IESE’s ability to quickly grasp our business mode and challenges, establish credibility with our internal teams, and provide concrete recommendations and results.”*

Further Reading:
 Business Area Information Systems
 p. 46
 Division Process Management p. 59

ZLB – Central State-Wide Treatment Capacity Indicator in Rhineland-Palatinate

Contact

Rolf Hendrik van Lengen
 Phone +49 631 6800-2103
 Fax +49 631 6800-9 2103
rolf.van.lengen@iese.fraunhofer.de



Rolf Hendrik van Lengen

Every day, hundreds of time-critical and care-intensive emergencies occur in Germany. However, despite all routine, efficient medical care along the entire chain of emergency services is never totally free of problems in reality. Even though Germany has nationwide emergency services with relatively short response times, valuable minutes often pass at the site of the emergency until a target hospital is found for the patient that is medically suitable, easy to reach, and, in particular, willing to accept the patient. Especially in vast emergency service center areas with a multitude of target hospitals, there is currently often a veritable “phone marathon”, frequently resulting in more than 10 to 15 minutes of time being lost.

Such practice is no longer state of the art and often also means an excessive workload for the dispatchers. Let’s look at a typical scenario to illustrate this issue. A 9-year old boy is hit by a car on his way to school. Due to massive pain and shock symptoms, the emergency physician is alerted immediately. He tells the dispatch office to find a “place for a hemodynamically instable child with blunt abdominal trauma and spinal trauma”. To do so, the dispatcher must successively check a total of five hospitals. At the first hospital, the shock room is already occupied; at the second hospital, his request is denied with a reference to the capacity for intensive care patients; the third hospital checks and says that it can currently treat only the abdominal injury, but not the spinal injury; the fourth hospital reports that children cannot be treated in general. After a total of 25 minutes on the phone, a major regional hospital 80 km away agrees to accept the child. This was the only hospital where direct information could be obtained, whereas in the other four hospitals, the request had to be relayed internally, sometimes more than once. Due to the distance, a rescue helicopter is called to transport the child to the hospital. In the end, the time difference between accident and arrival at the hospital is 90 minutes.

Despite the fact that the child could be saved, this case impressively demonstrates the problems and delays resulting from a method for checking on treatment capacities that is no longer state of the art. Innovative technological solutions can make the necessary information available not only much faster, but also with less effort by the extremely busy dispatchers as well as the hospitals being queried. On behalf of the state of Rhineland-Palatinate, Fraunhofer IESE has therefore developed a web-based information system – the so-called ZLB – which shows the current readiness of a hospital to accept patients to the dispatchers in real time. The State Emergency Service Act and the State Hospital Act stipulate that hospitals shall report their acceptance and care capacities to the (integrated) emergency service centers. This information can now be entered directly into the ZLB by the hospital or the respective dispatch center.

Collaboration Partner

Ministry of the Interior,
 for Sports and Infrastructure
 of the State of Rhineland-
 Palatinate
www.isim.rlp.de

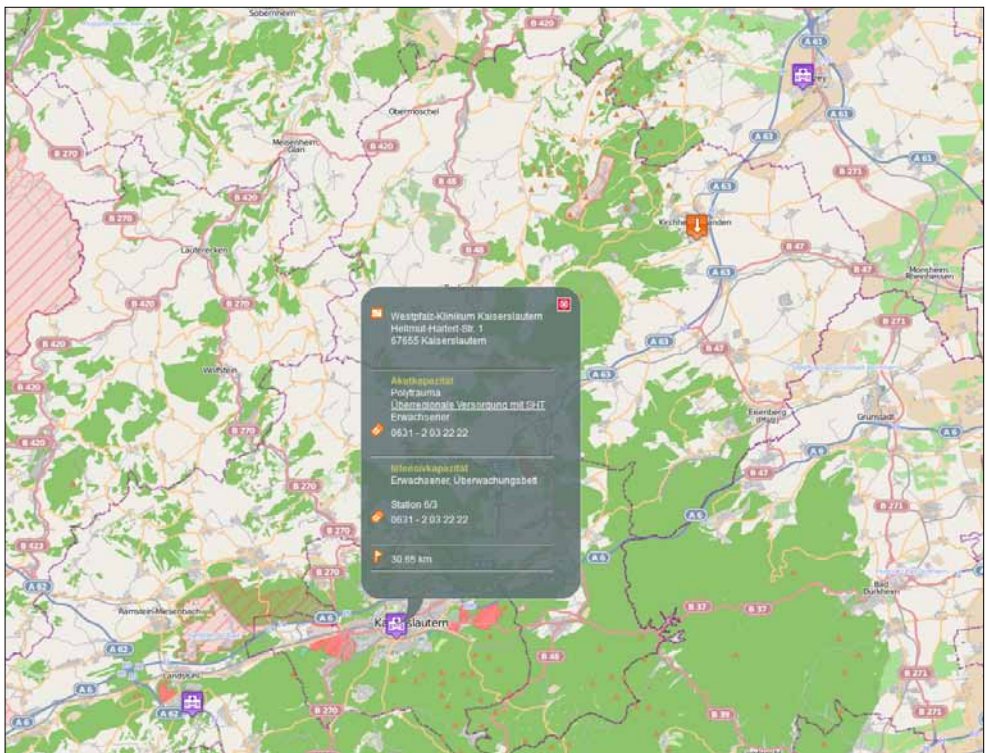

Result presentation of a query to the ZLB (excerpt). In this example, the query was for hospitals that have free capacities for a patient from the town of Kirchheimbolanden with polytrauma and that can offer subsequent intensive care. If necessary, detailed information can be overlaid directly on the map (here: the Westpfalz-Klinikum Kaiserslautern).

Depending on the site of the emergency, the dispatcher can check all available capacities statewide, which are then displayed as a table, resp. on a map, with all necessary information. The focus is not only on the issue of available regular and intensive care beds, resp. special infrastructure, but also on the emergency care capacities that are available. This includes, for example, for polytrauma patients the features shock room, CT capacity, and surgical capacity, and for patients with a fresh stroke an immediately available CT and the option of fibrinolysis.

As part of quality management, all status changes are recorded and can be analyzed in terms of various aspects. The extension of the system for use during catastrophic events is planned for 2012.

Further Reading:

- Business Area Health Care p. 50
- Division Process Management p. 59

MULTI – Multi-Touch Interaction for Smart Homes, Energy Management und (Virtual) Museums

Contact

Dr. Martin Wessner
Phone +49 631 6800-2118
Fax +49 631 6800-9 2118
martin.wessner@iese.fraunhofer.de



Dr. Martin Wessner

In many areas of our modern life, we are confronted with a large amount of complex and inter-connected data. Without suitable support from intuitive user interfaces, it takes a lot of effort to understand these and work with them – provided this is even possible at all.

The relevance and value of this information is usually strongly dependent on the user, the situation, and the task at hand. Merely visualizing such amounts of data is generally not useful by itself – it takes intuitive interaction to ultimately support the user effectively and efficiently. Support for both processes – visualization and interaction – is integrated in modern multi-touch devices.

Modern smartphones, laptops with multi-touch screens, interactive tables and walls – there exists a multitude of multi-touch hardware and software technologies as well as a variety of different forms of multi-touch interaction. Differences in display size, operating system, computing performance, detection functionality, gestures, etc. make it extremely hard to develop applications that can be used across multiple devices or classes of devices.

The implication of this is that new obstacles appear with every new device and every new technology, and that enormous effort is required to remain market-viable. This prevents especially small and medium-sized enterprises as well as public institutions (such as museums) from investing in this area, since the risk is extremely high. Committing to the “wrong” technology or the “wrong” manufacturer might make complete and expensive re-development necessary.

In order to ensure investment protection and broad applicability of the multi-touch approach, the objective of the project “MULTI – Development and Testing of a Framework for Scalable Multi-Touch Interaction” is to develop the basis for a framework that supports the largely device-independent design of multi-touch applications. This comprises evaluated forms of multi-touch interaction, a scalable software architecture, as well as exemplary, domain-specific software libraries. The central goal is the development of an intermediate layer that allows the application to select from a number of different multi-touch gestures and, in doing so, abstract from the underlying hardware-specific multi-touch framework.

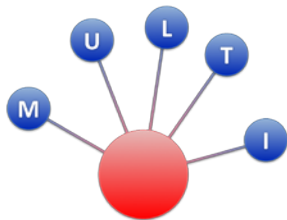

This project is being funded by
Stiftung Rheinland-Pfalz für
Innovation.



In order to be able to also identify and analyze cross-domain interaction patterns, two fundamentally different application areas are involved in this project:

- In the application area “Smart Home and Energy Management”, a user is faced with time-dependent state and usage information from many devices in an apartment or in a building complex. There are high requirements on the context-specific interaction with complex data sets. In the context of the project, the demonstrator for Smart Home and Energy Management applications developed at Fraunhofer IESE will be extended with multi-touch hardware and software. This will then be used as a basis for identifying, implementing, and evaluating domain-specific forms of interaction in a dialog with industry experts.
- In the application area “Interactive Virtual Museums”, infotainment aspects for a broad audience are the main issue. Depending on the conceptual design of the respective museum, visitors explore complex content (such as game statistics) alone or in groups, experience What-If simulations, or work on understanding a piece of art along historical, geometric, or color-related dimensions. In the context of this project, Fraunhofer IESE is collaborating with the local soccer club 1. FC Kaiserslautern regarding the presentation of sports-related content and exhibits, as well with the art museum Museum Pfalzgalerie Kaiserslautern regarding the presentation of a great variety of works of art. Typical forms of interaction are identified and different demonstrators are being designed and evaluated in collaboration with these application partners.

“Foosball” with two players on the multi-touch table.

Collaboration Partners

TU Kaiserslautern
hci.uni-kl.de

1. FC Kaiserslautern e.V.
www.fck.de

Museum Pfalzgalerie
 Kaiserslautern
www.mpk.de

Further Reading:

Business Area Information Systems

p. 46

Division Process Management p. 59

JOHN DEERE: Design and Prototype Implementation of a Mobile Task Management Solution

Contact

Ralf Carbon
Phone +49 631 6800-2138
Fax +49 631 6800-9 2138
ralf.carbon@iese.fraunhofer.de



Ralf Carbon

Collaboration Partner

John Deere
www.johndeere.com



Software and services play an ever increasing role in agriculture. Farmers, contractors, and their employees want to exploit the potential of modern IT to support their workflows and optimize their productivity. Manufacturers of agricultural machinery, such as John Deere, therefore face the challenge of having to develop software and services to support agricultural workflows. Mobile devices such as smartphones and tablets play an ever greater role in this context, since they offer the possibility to access agricultural data on the road and use mobile IT services.

Since 2009, John Deere and Fraunhofer IESE have been collaborating on the topic of mobile applications in agriculture. The aim of this collaboration is to demonstrate the potential of mobile devices and platforms in agriculture with concrete examples, to evaluate the technologies in prototype development, and to identify lessons learned, respectively best practices for the development of mobile applications in the context of John Deere.

In the project "Grower's Notebook", a mobile task management solution for farmers, contractors, and their employees was designed and implemented in a prototype. Using this solution, a farmer or contractor can create a task on an iPad, such as the harvesting of a particular field, and assign this task to one of his employees. The employee gets all the information needed for completing the task sent to his smartphone. He can then use his smartphone for documenting the task, e.g., to keep track of working hours, but also to report the current status of the task or any problems that may occur. With the help of a camera integrated into the mobile device, pictures can be taken and added to the task documentation.

The results of the project are prototypes of an iPad app for farmers and contractors as well as an iPhone app for their employees. The apps were developed using Fraunhofer IESE's state-of-the-art methods for mobile business applications. This included, for example, analyzing the common workflows between farmers, contractors, and their employees and determining the potential for the use of mobile devices. The use of creativity techniques helped to generate



concrete ideas for a mobile task management solution. During the architecture design phase, a solution was designed that allows seamless integration with an existing farm management solution in order to ensure smooth data exchange between mobile devices and backend systems. Potential end-users were involved in the engineering process early on in order to obtain valuable feedback.

The application of the Fraunhofer IESE methods resulted in a transfer of these methods from Fraunhofer IESE to John Deere during the course of the project. John Deere thus received support for systematically developing such mobile applications on its own in the future.

In September 2011, the results of the project "Grower's Notebook" were presented to high-level representatives of John Deere, including the current CEO Sam Allen, at the European Technology Innovation Center (ETIC) in Kaiserslautern and were received positively by everyone.

Christian Bartolein, Advanced Engineering, John Deere European Technology Innovation Center:
"Through the collaboration with Fraunhofer IESE, John Deere learned valuable lessons regarding the design and implementation of mobile applications. The support by Fraunhofer IESE has enabled us to better assess the potential of such applications for use in agriculture. With the help of the jointly developed prototypes, we have already been able to get initial feedback from our customers."

John Deere and Fraunhofer IESE will continue to cooperate in 2012 on the topic of mobile devices and mobile business applications.

Further Reading:

Business Area Automotive and
Transportation Systems p. 40
Division Information Systems p. 63

ACCENTURE CAS: Methodological Support for the Architecture Definition of the New Mobile Platform

Contact

Ralf Carbon
Phone +49 631 6800-2138
Fax +49 631 6800-9 2138
ralf.carbon@iese.fraunhofer.de



Ralf Carbon

Collaboration Partner

Accenture CAS
[www.accenture.com/
accenturecas](http://www.accenture.com/accenturecas)

Accenture CAS, headquartered in Kaiserslautern, develops and sells the software Accenture CAS (currently release 9), a comprehensive solution that supports the sales of large brand-name manufacturers in the consumer goods industry. This software does, for example, allow scheduling visits of sales representatives to customers and supports such visits on site. A sales representative can use a mobile device to which all data necessary for the customer visit are downloaded and which allows collecting additional data at the customer's site regarding the current inventory or recording orders. The Accenture CAS software thus consists of both server-side components and applications that are installed and used on mobile end devices.

The mobile application that is currently being used by many customers is based on Microsoft Windows Mobile, i.e., a technology that can hardly keep up with modern competition from new mobile operating systems such as Apple's iOS or Google's Android. Users of the Accenture CAS software expect mobile solutions that exploit the possibilities offered by modern mobile platforms and devices in order to support their workflows in the best possible way and enable high user experience. In 2011, Accenture CAS thus faced the challenge of having to create a basis for the development of mobile applications on platforms such as Apple's iOS, Google's Android, or Microsoft's new platform Windows Phone 7. This basis includes a software platform based on which individual mobile applications can be developed for various customers of Accenture CAS and for different mobile operating systems, resp. devices. Requirements on this platform, resp. on the mobile applications developed with it, include:

- Flexibility, to allow addressing the requirements of different customers
- High performance of the applications on the mobile device and/or the backend connection
- Reuse between different mobile operating systems (iOS, Android, WP7)

Ensuring the fulfillment of these requirements calls for a sound architecture of the platform and a systematic procedure during its definition.



In 2011, the task of Fraunhofer IESE in the collaboration with Accenture CAS primarily consisted of providing methodological support for the architecture definition of the new mobile platform. This included support for both the elicitation of requirements and the design of the architecture. For the elicitation of requirements, the concept of architecture scenarios was introduced exemplarily to help make high-level requirements more concrete. In architecture design, the concept of architecture decisions and architecture views was used, and Fraunhofer IESE made proposals regarding the documentation of the architecture.

Collaboration took place in the form of joint workshops on site at Accenture CAS and via back-office work done by Fraunhofer IESE. In the workshops, the methodological contributions of Fraunhofer IESE were introduced and used directly on concrete examples. In addition to its methodological contributions, Fraunhofer IESE thus also made concrete architecture solution proposals, respectively gave feedback on the architecture decisions made by Accenture CAS. Furthermore, Fraunhofer IESE actively participated in creating the architecture documentation and documented large parts of the high-level architecture by itself in the back office.

The concrete result of the collaboration between Accenture CAS and Fraunhofer IESE in 2011 is thus not only the transfer of methodological knowledge about architecture, but also a first version of the architecture of a new mobile platform, which in the meantime has entered the refinement resp. implementation phase. Collaboration regarding the mobile platform is scheduled to continue in 2012.

Further Reading:

Business Area Information Systems

p. 46

Division Information Systems p. 63

DESY: Business-Process-oriented IT Solutions at Deutsches Elektronen-Synchrotron

Contact

Sebastian Adam
 Phone +49 631 6800-2176
 Fax +49 631 6800-9 2176
sebastian.adam@iese.fraunhofer.de



Sebastian Adam

Michael Eisenbarth
 Phone +49 631 6800-2181
 Fax +49 631 6800-9 2181
michael.eisenbarth@iese.fraunhofer.de



Michael Eisenbarth

Today, hardly any organization can make do without IT support for its business processes. In addition to companies and government agencies, this increasingly also affects research organizations, which are often similar in size and complexity to a medium-sized enterprise and sometimes even larger. At the Deutsches Elektronen-Synchrotron (DESY) in Hamburg, for example, about 2000 employees and 3000 guest scientists are working in the areas of construction and operation of accelerators, photon science, as well as particle and astroparticle physics. Since the effective and efficient operation of such a research institution can only be ensured with the appropriate IT support, corresponding solutions must be adapted strategically to the existing needs. To do this, DESY has in the past developed and established internally suitable methodological processes.

In the context of the DESY-internal projects "GO" and "KDS", DESY has been cooperating since 2011 with Fraunhofer IESE, where the research and work foci include methodological introduction of information systems in general and requirements engineering including the modeling of business processes and system architectures in particular. The aim of this collaboration is to drive the mutual exchange of experience in the area of business-process-oriented IT solutions and to optimize methodological processes regarding the sustainable introduction of appropriate concepts.

In the context of the project "GO – Business Process Optimization using an Identity and Access Management System", DESY intends to create the organizational and technical basis for making business processes more efficient and transparent. In order to create the methodological foundation, the first step was to capture and analyze the business processes. Following the introduction of a suitable software solution (BPM Suite), they were mapped electronically and made accessible via a central end-user portal. In addition to the elicitation and modeling of selected pilot processes, Fraunhofer IESE was involved in the analysis of the current system landscape as well as in the derivation of requirements on tool support for business process

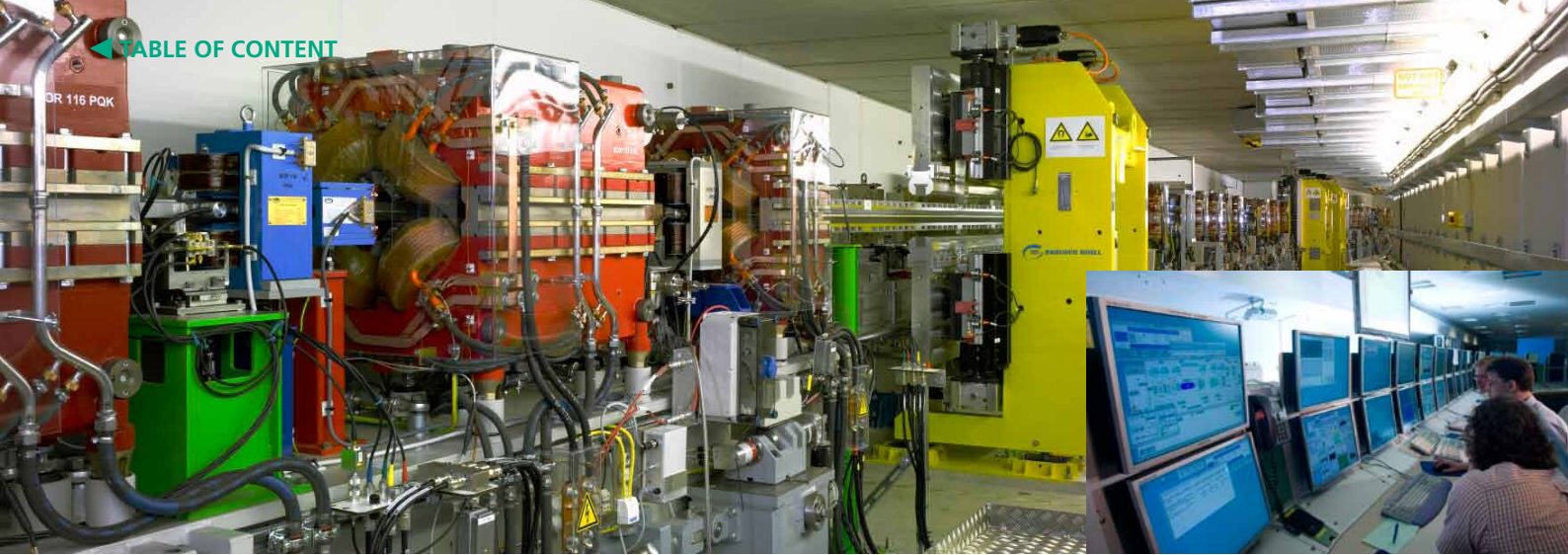

and identity management. The subject of the collaboration to date has been the preparation, execution, and packaging of process and system elicitation workshops with representative stakeholders as well as the documentation of the already existing information systems and the development of tender documents.

In 2012, Fraunhofer IESE will continue its collaboration in the context of "GO" and support the to-be definition of the pilot processes. Another goal is the development of an operative concept for business process management in order to sustainably establish the desired processes at DESY.

In addition to systems for integrated business process support, DESY also uses special information systems for the documentation and coordination of engineering tasks in plant construction and operation. One of these systems, a cable documentation system (KDS), serves as the central source of information at DESY for the creation and documentation of cable installations.

In another joint project, DESY and Fraunhofer IESE are working on an operation and function concept for the KDS to facilitate its future operation and possible extensions. To this end, Fraunhofer staff are eliciting and analyzing the current operation requirements and the necessary functional extensions for use in future projects. One of these projects is aimed not only at documenting, but also at using the KDS in the early cable planning processes already. The goal of the project is the consolidation and prioritization of all requirements in an integrated operative and framework concept that can be used to assess and prioritize the system evolution that will become necessary in the next few years.

© DESY

Not only particles are being accelerated at the Deutsches Elektronen-Synchrotron in Hamburg – in the future, the internal business processes will be accelerated as well. Fraunhofer IESE provides support for the introduction of appropriate IT solutions.

Collaboration Partner

Deutsches Elektronen-Synchrotron (DESY)
www.desy.de



Further Reading:

- Business Area Information Systems p. 46
- Division Information Systems p. 63

INSIDERS TECHNOLOGIES: Positive User Experience – Interaction Design

Contact

Dr. Marcus Trapp
Phone +49 631 6800-2186
Fax +49 631 6800-9 2186
marcus.trapp@iese.fraunhofer.de



Dr. Marcus Trapp

Further Information

Competence Page
www.iese.fraunhofer.de/en/competencies/user_experience.html



Insiders Technologies GmbH offers intelligent products and solutions centering on input management for optimizing document-related business processes. Business-relevant information from documents is analyzed in a needs- and media-appropriate manner and made available in a company in whichever way required by the input channel and subsequent business events.

With “smart Cockpit”, a new product has been developed for monitoring a company’s business processes. It is not only about sub-processes relating to document management, but about entire business processes, including both prior and subsequent sub-processes. “smart Cockpit” allows companies to recognize problems early on and take appropriate actions.

Fraunhofer IESE supported Insiders Technologies in the development of an innovative interaction design for “smart Cockpit” that is tailored to the needs of the customers, allows high usability, and promotes a positive User Experience.

Using the Fraunhofer IESE requirements methodology Satisfy, the first step was to elicit the strategic goals to be pursued with the new product. These then served as an important contribution to the elicitation of the requirements on the interaction design. In accordance with the principle of permanent customer dialog at Insiders Technologies, a workshop was then organized together with a working group consisting of representative customers and users in order to also capture the customer perspective. By using various creativity techniques especially combined for this situation (e.g., Lotus Blossom, Brainwriting, Remember the Future, Product Box), expectations as well as innovative features and quality requirements for the new product from the customer perspective were elicited in a relaxed atmosphere and prioritized initially. Afterwards the requirements were consolidated and categorized.

Based on the requirements voiced by management and those taken from the customer view, the Fraunhofer IESE UXelerate methodology was then used to determine the basic interaction concepts. In order to evaluate these designs as soon as possible, paper prototypes were created for selected use cases. These were evaluated in the Wizard-of-Oz mode together with Insiders Technologies, and improvement suggestions were collected.

For the evaluation of the interaction design by the working group of customers and users, the prototype tool Microsoft Expression Blend SketchFlow was used to create an executable low-fidelity prototype for the selected use cases, which was then evaluated during another workshop.



Requirements Elicitation and Creativity Techniques



Brainstorming



Lotus Blossom



Remember the Future



Brainwriting

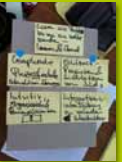



Product Box

Intermediate results on the way to the interaction design

Top: Excerpts from the photographic minutes of the creativity workshop

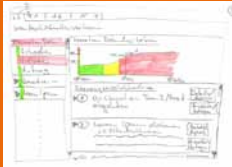

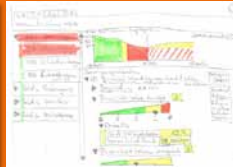
Paper Prototype

Center: Several templates as paper prototypes

Executable Low-Fidelity Prototype



Bottom: Several screen templates as Microsoft Expression Blend SketchFlow prototypes

With the individual method selection, the consistent inclusion of customers and users, and the permanent evaluation of the intermediate results, an innovative interaction design was developed that appeals to both Insiders Technologies and its customers.

“The methodological procedure as well as the creativity techniques of Fraunhofer IESE convinced and inspired both us and our customers, whom we could motivate in the context of a working group to participate in the development of the new product.”

Dr.-Ing. Michael Gillmann, Product Manager, Insiders Technologies GmbH

Collaboration Partner

Insiders Technologies GmbH
www.insiders-technologies.de



Further Reading:

Business Area Information Systems

p. 46

Division Information Systems p. 63

automotiveHMI – Optimized HMI Development in the Automotive Industry

Contact

Steffen Hess
Phone +49 631 6800-2275
Fax +49 631 6800-9 2275
steffen.hess@iese.fraunhofer.de



Steffen Hess

Further Information

Project Homepage
www.automotive-hmi.org



FUNDED BY



Bundesministerium
für Bildung
und Forschung

Today, innovations in the automotive domain are usually found in the areas of electronics and/or electrical engineering. Humans need user interfaces to use these innovations. Despite the increasing number of requirements, shorter product development cycles, and higher quality requirements, it must be ensured that the quality of these interaction interfaces remains high.

The goal of the project automotiveHMI is to optimize the development processes for user interfaces. This is achieved by first eliciting the current status of these processes and using this baseline for describing a future reference HMI development process. This reference process is an integrated approach based on standardized languages, models, and interfaces for all companies involved, from the automobile manufacturer via the supplier to the tool manufacturer.

Fraunhofer IESE as an independent partner ensures that the different interests are taken into account appropriately and that new, multimedia and multimodal forms of interaction of novel operating systems are also considered. One major issue is integrated development, if possible without any breaks in medium. This is achieved through the use of a modeling language that allows integrated, interdisciplinary, model-driven development. In this project, Fraunhofer IESE is in charge of requirements elicitation, development of the reference process, and definition of the HMI data model. Supportive work is also being done in the areas of HMI modeling language, model-based testing of HMI components, and change management.

During the first phase of the project, the analysis phase, Fraunhofer IESE was deeply involved in the development of a catalog of questions for systematically eliciting current processes as well as involved roles, tools, and interfaces among the partners. This catalog of questions was first sent electronically to all partners to allow them to prepare; later, all important information was elicited during an on-site workshop and ambiguous issues were clarified. The elicited information was analyzed, packaged individually, and sent to the partners for review and internal approval. Finally, an anonymized document summarizing the comprehensive results of the entire analysis phase was created.

The methodological procedure used here ensures that the quality of the elicited information is high, which made it possible to use this document to define an abstract HMI reference development process to which OEMs and suppliers as well as tool manufacturers can relate and which will now serve as a basis for further activities in the project.

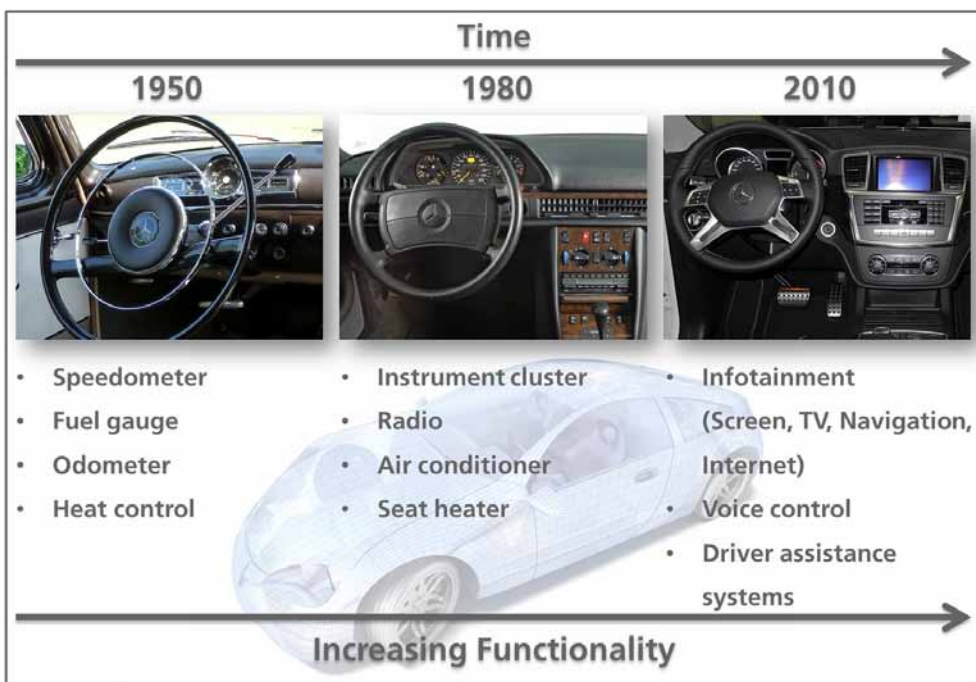

Increasing complexity in HMI development

Collaboration Partners

AUDI AG
www.audi.de

comlet Verteilte Systeme GmbH
www.comlet.de

Daimler AG
www.daimler.de

DFKI
www.dfki.de

Dr. Ing. h.c. F. Porsche AG
www.porsche.de

Elektrobit Automotive GmbH
www.elektrobit.de

Robert Bosch Car Multimedia GmbH
www.bosch.com

Volkswagen AG
www.vw.de

Further Reading:

Business Area Automotive and Transportation Systems p. 40
 Division Information Systems p. 63

Central goals during the second phase of the project on the part of Fraunhofer IESE are the definition and development of a data model, the reduction of the complexity of HMI development processes, and the determination of the elements to be developed by the modeling language. On the basis of the reference process developed during the first phase, Fraunhofer IESE is currently defining the objects to be managed in the HMI tool chain and is specifying their attributes and relationships. In addition, representative, data-specific use cases are being derived for the data model to be developed before concrete development of this model takes place, which will serve as input for the modeling language created during the further course of the project.

P23R | Prozess-Daten-Beschleuniger: Simple, Safe and Efficient Fulfillment of Information Obligations

Contact

Norman Riegel
Phone +49 631 6800-2265
Fax +49 631 6800-9 2265
norman.riegel@iese.fraunhofer.de



Norman Riegel

Collaboration Partners

A total of 13 partners from industry and research
www.p23r.de

In the context of the German Federal Government's IT investment program, the project P23R | Prozess-Daten-Beschleuniger ("Process Data Accelerator") was performed from June 2010 to November 2011 on behalf of the Federal Ministry of the Interior. 13 partners from industry, academia, and public administration developed the methodological, technical, and organizational basis for the design of simple reporting processes between companies and government agencies without changes in medium. The P23R principle developed by the project team allows the systematic reduction of redundancies regarding the fulfillment of the legal information obligations.

Within the P23R project, a uniform framework- and safety architecture was designed. It provides a building plan for the implementation of P23R solutions in the respective business context. On the basis of this framework architecture, a prototype was developed that was piloted successfully in companies and government agencies in the Rhine-Neckar metropolitan region for various employer and environmental reporting obligations. This provided evidence of the applicability of the P23R principle in practice. Through the use of P23R solutions, the work effort that companies need to expend to handle government-imposed information and reporting obligations is reduced. The introduction of a P23R solution also reduces the costs for adapting IT information systems to changes in legislation. To support the implementation of the P23R principle, modular method guidelines were developed, which are available as an online version for decision makers in business and public administration.

In this project, Fraunhofer IESE was primarily responsible for quality management, for coordinating work on technical and organizational constraints, as well as for acceptance and change management. In addition, a prioritization methodology was developed for the method guidelines, which allows characterizing process chains between business and public administration regarding their usage potential and ranking them according to the implementation priorities.



Bundesministerium
des Innern



IT-INVESTITIONS-
PROGRAMM
Wir gestalten Zukunft.

This project is being funded from the IT Investment Program of the Federal Government.

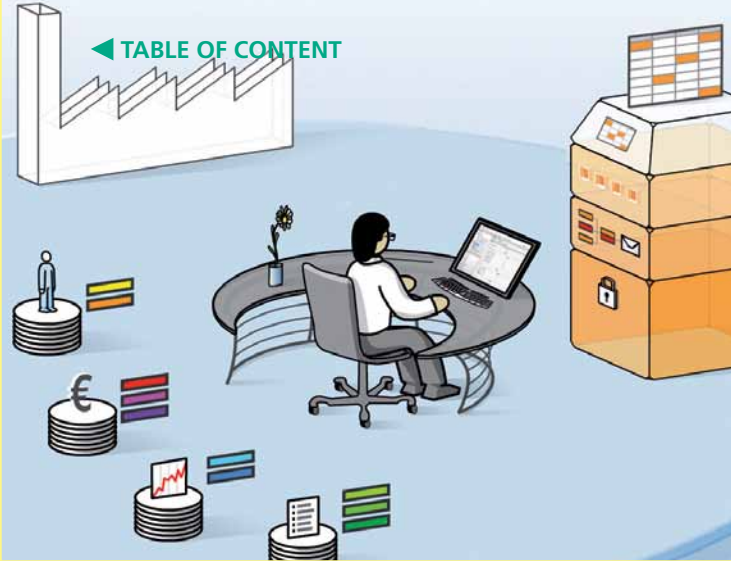

The solution approach for the re-design of process chains between business and public administration that was developed in the project required an interdisciplinary procedure where representatives of different areas collaborated in order to achieve a tested and coherent overall result. The realization of independent quality management to support the project management, which was done by Fraunhofer IESE, was therefore of major importance in the project. In principle, two dimensions of quality assurance could be distinguished in the P23R project: On the one hand, quality assurance had to ensure on the operative level that the project results corresponded to the prerequisites and plans defined in advance in order to guarantee that the goal was achieved in terms of quality, quantity, and time; on the other hand, it had to control the process of multi-perspective evaluation in close cooperation with the project management. One particular challenge for quality management in the P23R project was the need to synchronize the various actors all across Germany in such a way that their respective professional expertise could be incorporated into an integrated quality assurance process.

P23R completely re-designs the exchange processes between business and public administration. Such a fundamental change in paradigms can only work if all stakeholders see the changes as positive and accept them. Fraunhofer IESE was responsible for developing and deploying suitable acceptance and change management methods in order to design communication regarding the P23R principle in such a way that all stakeholders will realize its benefits. To do so, Fraunhofer IESE identified factors promoting acceptance and those hindering acceptance for different target groups, as well as success factors of comparable large-scale eGovernment projects, in order to provide advice to the project team during the implementation of P23R and the development of roll-out concepts.

Presentation of the central project results of the P23R project at the 6th National IT Summit in Munich, where high-ranking government and business representatives could take a look at the chancellor's P23R exhibit. (Image source: Hans-Joachim Rickel, Federal Ministry of the Interior)

Further Information

Project Homepage
www.p23r.de



NON-STOP-GOVERNMENT

Further Reading:

Business Area eGovernment p. 48
 Division Information Systems p. 63

ATTRACT – Security for Distributed Data

Contact

Dr. Jörg Dörr
 Phone +49 631 6800-1601
 Fax +49 631 6800-9 1601
joerg.doerr@iese.fraunhofer.de



Dr. Jörg Dörr

Collaboration Partners

Fraunhofer IOSB
www.iosb.fraunhofer.de

Karlsruhe Institute for
 Technology KIT
<http://zvi.ipd.kit.edu/>



The Project "Distributed Data
 Usage" is funded by the Fraunhofer
 ATTRACT Program.

Nowadays, IT applications and services in both the personal and business spheres exchange a large amount of information from their users. This data exchange sometimes goes unnoticed, and poses business and personal threats if adequate security measurements are not taken. Examples of these threats are identity theft, disclosure of strategic business data, and a loss of reputation due to privacy violation incidents reported in the media. Therefore, in order to increase confidence in the quality of their services, it is important for organizations to ensure that the data they exchange with their clients is not misused or handled insecurely. In the same way, end users must be enabled to control (personal) data that they transmit to companies.

This calls for classical security approaches like access control to be extended to protect data once it is distributed for various usage scenarios. Usage control extends access control by enabling the specification of obligations in the form of so-called policies on the usage of data that should be fulfilled after access is granted. Such policies contain fundamental requirements in scenarios where multiple stakeholders share sensitive data among each other. Examples of usage control applications are protection of business secrets in business collaborations, enforcement of privacy and compliance regulations when end users provide their data to services or applications, and protection of digital content owners' copyrights.

To specify usage control policies, we adopt a formal language that supports complex policy conditions with temporal, local, and cardinality operators. For example, a customer may require that all credit card information is deleted as soon as payment is completed. In Ambient Assisted Living (AAL) environments, the assisted persons might not be comfortable knowing that a record of all their activities at home and their health data are stored in a non-anonymized format for long periods of time. In business contexts, customers would prefer to do business with companies that have explicit usage control solutions in place that inform them every time their records are provided to third parties in case part of their business processes are outsourced. When business data is stored in mobile devices, usage control must be in place to prevent malicious mobile applications from accessing company secrets and details about the corporate environment.



Such policies are enforced by two main components: a Policy Decision Point (PDP) and a Policy Enforcement Point (PEP). The PDP component is technology independent and is responsible for interpreting the policy language and configuring the technology-specific PEPs into signal events. PEPs are responsible for observing when actions of interest are performed in the system as well as for signaling events to the PDP component. In Attract, the vision is that PEPs should be deployed on different layers of abstraction (e.g., operating system, web browser, Java Virtual Machine, etc.), should be able to intercept activities executed in the running system, and should carry on the enforcement of the policies on different layers of abstraction. In order to ensure that the specified policies are enforced by the PEP, guarantees have to be provided with respect to the integrity of all system components. In Attract, we build on the results of the EU research project MASTER, which produced basic technology for usage control operationalization with respect to specification, enforcement, and guarantees.

The Attract project resources are shared between the Fraunhofer institutes IESE and IOSB, with KIT as a scientific cooperation partner. At Fraunhofer IESE, the research focus is on methodology and domain-specific issues. From a methodological perspective, the researchers at Fraunhofer IESE are working on meta-models and tools for model-based usage control engineering and usability issues in usage control policy specifications. The domain-specific work focuses on usage control concepts for Ambient Assisted Living (AAL) and mobile scenarios, exploiting the synergy with other Fraunhofer IESE research projects. The results of its research allow Fraunhofer IESE to provide guidance to its customers regarding the easy specification and implementation of usage control solutions for information systems to prevent data misuse and increase confidence in business collaborations.

Further Reading:

Business Area Information Systems
p. 46
Division Information Systems p. 63
Project Report Software Cluster
p. 100

SOFTWARE CLUSTER: Enforcement of Security Policies across Corporate Boundaries

Contact

Dr. Christian Webel
Phone +49 631 6800-2185
Fax +49 631 6800-9 2185
christian.webel@iese.fraunhofer.de



Dr. Christian Webel

Further Information

Project Homepage
www.software-cluster.org



Collaboration Partners

A total of 38 partners from industry and research
www.software-cluster.org

The Software Cluster in southwestern Germany is considered Europe's Silicon Valley. Clustered around the software development centers Kaiserslautern, Darmstadt, Karlsruhe, Saarbrücken, and Walldorf are well-established universities, companies, and research institutions that are working together in close cooperation. They are jointly developing concepts and solutions for the enterprise software of the future, i.e., software for the management of business processes within and particularly between companies. There are currently three joint research projects with a total volume of more than 53 million euros; a fourth project is in the planning phase. As the consortium leader of the flagship project EMRGENT, Fraunhofer IESE is deeply involved in research and development for future concepts and solutions.

As a central result of the joint research project EMRGENT, a concept was developed by Fraunhofer IESE in a cross-organizational context for the enforcement of so-called security policies intended to regulate access to and use of sensitive data (usage control). Central components of this concept are a technology-independent decision component for security policies, the so-called Policy Decision Point (PDP), and several technology-dependent components, the Policy Enforcement Points (PEP). A PEP serves to intercept all messages on one level of abstraction (e.g., on the service level inside an enterprise service bus) and to forward, block, modify, or delay them based on the decision of the PDP. Additional actions can also be triggered, such as the creation of a log file or notification of responsible persons. In addition, reputation models are used for assessing trust in services on the basis of cross-organizational feedback and expert knowledge. The decision, i.e., the actual security policy, is formulated with the help of the policy language OSL (Obligation Specification Language). This allows specifying strong usage control in order to ensure the flow of information and thus the protection of the data. It is thus possible, for instance, to restrict the use of specific data to recipients determined a priori (who are thus authorized), or to limit the type and frequency of processing (e.g., by means of cardinal and temporal operators). The scientific highlights of the concept are:

- Technology-independent specification of security requirements through a generic central policy decision point (PDP)
- Technology-dependent policy enforcement points (PEP)
- Use of temporal and cardinal operators in the policy language for expressing future-oriented policies (forward obligations)
- Enforcement of security policies on various levels of abstraction (e.g., operating system, service, or application level) controlled by a central decision component

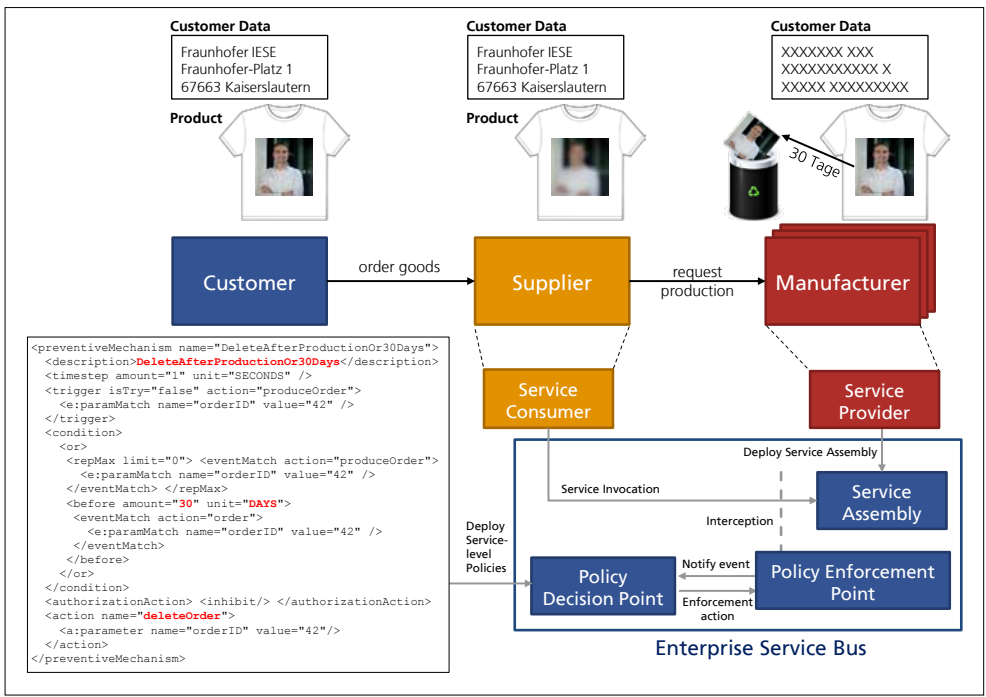

Enforcement of cross-organizational security policies on the service level illustrated on the enterprise service bus (ESB): Sensitive data such as customer data or production-relevant information is only visible to the companies involved in the respective process step. In addition, the security concept also allows controlling the future usage of the data beyond corporate boundaries (e.g., deletion of sensitive data after 30 days).

Another one of the cluster's projects, SWINNG, focuses on designing suitable development processes for the enterprise software of the future and on the so-called cluster governance, i.e., the optimization of the cluster's internal workflows, as well as on the dissemination of the developed innovations within the cluster region and beyond. One of the central tasks of Fraunhofer IESE is the evaluation of the cluster as such as well as the developed concepts and solutions. In this regard, the networking between the cluster partners and the qualification demand of specialists are examples of what was investigated last year. Currently, more empirical studies are being set up to study the concrete added value of the cluster concepts and solutions in industrial practice. Another task is to capture and optimize the critical workflows within the cluster itself. This includes, for example, processes regarding technology transfer, support for new entrepreneurs, or international communication / public relations. Fraunhofer IESE thus makes a central contribution to the evolution of the Software Cluster.

The joint research projects within the Software Cluster are funded by the German Federal Ministry of Education and Research (BMBF) in the context of the High-Tech Strategy under grant numbers 01|C10S01A (EMERGENT) and 01|C10S05| (SWINNG).

Further Reading:

- Business Area Information Systems p. 46
- Division Information Systems p. 63
- Project Report Attract p. 98



FUNDED BY



FIBUNET: Keeping the Figures under Control through Continuous Modernization

Contact

Matthias Naab
 Phone +49 631 6800-2249
 Fax +49 631 6800-9 2249
matthias.naab@iese.fraunhofer.de



Matthias Naab

For more than 15 years, FibuNet has been developing and selling one of the leading software systems for financial accounting, also named FibuNet. As a medium-sized enterprise headquartered in Kaltenkirchen, FibuNet's accounting competence and its ability to cast this into software have allowed it to establish a customer base of more than 1300 customers, ranging from small companies to major chains such as Netto Marken-Discount.

Financial accounting software must be continually adapted in order to correctly reflect the current legal situation and provide optimal support for workflows. In addition to content-related adaptations, moderate technological modernizations are also needed regularly in any software system that is built to last a long time. This is the only way to ensure benefits such as modern user interfaces, optimal use of hardware supplies, and efficient development approaches. In the past, FibuNet had repeatedly performed such modernization steps. Recently it decided to replace the high-performance data management framework developed in-house, which required a lot of maintenance, with the commercial database technology Microsoft SQL Server. This transition also implies a change in the architecture paradigm, since many architecture concepts differ fundamentally between the old and the new solution and thus impact existing system parts. Of course, the system's high performance, in particular, which constitutes a clear competitive edge, must not be jeopardized during this transition. Therefore, FibuNet decided to perform a migration project focusing primarily on maintaining the existing system properties and making moderate improvements.

Collaboration Partner

FibuNet GmbH
www.fibunet.de



In order to get an early external evaluation of the future architecture, Fraunhofer IESE was included in the project and asked to assess the suitability of the planned architecture changes. In the scenario-based architecture evaluation, emphasis was placed especially on the accurate representation of all important quality properties, above all performance. The future architecture designs were discussed in intensive cooperation with the architects and developers of FibuNet. This made it possible to corroborate that FibuNet has made many suitable architecture decisions to ensure that all requirements on the system will also be fulfilled in the future. Additional measures could be derived for safeguarding performance, which can now be used for accurately targeting the migration project. In 2012, FibuNet will complete the migration and then make their software system even more attractive with new concepts, for example in the area of user interaction.



FibuNet 31.12.2011/1 (907) *Kopie vom 30.03.2011 Markus Muster GmbH

FibuNet - Druckvorschau [Bilanz - Vergleich.htm] FibuNet (20047) TFRMDRU09_02 v1.13 (907) *Kopie vom 30.03.2011 Markus Muster GmbH per 31.12.2011 und per 31.12.2010 EUR

FibuNet (20047) TFRMDRU09_02 v1.13 (907) *Kopie vom 30.03.2011 Markus Muster GmbH per 31.12.2011 und per 31.12.2010 EUR

4.8.5 Bilanz - Vergleich [Bilanz - Vergleich.htm] | FV

eb am 30.03.2011 um 09:43
Seite 1 von 2

Bilanz - Vergleich (HGB)

Gruppendaten		Basisdaten		Vergleichsdaten			
Pos	Gruppenbezeichnung	Aktiva	Passiva	Aktiva	Passiva	Abweichung	Abweichung in %
100	Konzessionen, gew. Schutzrechte	64.683,00		64.683,00		0,00	0,00
150	Andere Anlagen, BGA	246.506,99		142.770,11		-103.736,88	-42,08
Kontrollr	MD Kontobezeichnung	Aktiva	Passiva	Aktiva	Passiva	Abweichung	Abweichung in %
320	907 PKW	99.232,20		99.232,20		0,00	100,00
350	907 LKW	39.991,11		39.991,11		0,00	0,00
400	907 Betriebsausstattung	4.201,68		-4.201,68		-4.201,68	-100,00
415	907 EDV-Hardware	2.442,00		2.442,00		0,00	0,00
630	907 Ladeneinrichtung	100.347,00		100.347,00		0,00	0,00
250	Fertige Erzeugnisse und Waren	7.150,40		7.150,40		0,00	0,00
270	Forderungen aus Lieferungen und Leistungen	2.181.648,41		2.190.008,41		8.360,00	0,38
280	Forderungen gegen verb. Unternehmen	19.992,00		19.992,00		0,00	0,00
300	Sonstige Vermögensgegenstände			10.911,06		-10.911,06	-100,00
340	Schecko.Kassenbest. Banliguth.	10.289,74		10.289,74		0,00	0,00
Kontrollr	MD Kontobezeichnung	Aktiva	Passiva	Aktiva	Passiva	Abweichung	Abweichung in %
1000	907 Kasse Sonderaktionen	2.516,27		2.516,27		0,00	0,00
1100	907 Postbank	15.772,47		15.772,47		0,00	0,00
400	Gezeichnetes Kapital		100.000,00		100.000,00	0,00	0,00
460	Gewinn-/Verlustvortrag		350.023,23		350.023,23	0,00	0,00
500	Sonstige Rückstellungen		4.500,00		4.500,00	0,00	100,00
520	Verb. gegen Kreditinstitute		350.000,00		350.000,00	0,00	0,00
540	Verb. aus Liefern. Leistungen		517.019,48		517.019,48	0,00	0,00
560	Verb. gegen verb. Unternehmen		89.800,00		89.800,00	0,00	0,00
580	Verbindlichkeiten aus Steuern		182.060,78		171.310,01	-10.750,77	-5,91
Kontrollr	MD Kontobezeichnung	Aktiva	Passiva	Aktiva	Passiva	Abweichung	Abweichung in %
1970	907 Abschreibung Vorzieher	89.941,33		89.941,33		0,00	100,00
1974	907 US innergem. Erwerb 10% (8/89)	2.898,00		-2.898,00		-2.898,00	-100,00
1700	907 sonst. Verbindlichkeiten		25.000,00		25.000,00	0,00	0,00
1755	907 Lohn- u. Gehaltsverrechnung		135.000,00		135.000,00	0,00	0,00
1774	907 US 7% - fällige US - Schlussel 2		357,64		357,64	0,00	100,00
1774	907 US innergem. Erwerb 10 % (89)		2.898,00		2.898,00	0,00	100,00
1775	907 US 10% - fällige US - Schlussel 8		112.622,86		112.622,86	0,00	100,00
1789	907 US laufendes Jahr	12.108,30		-12.108,30		-12.108,30	-100,00
1790	907 US Vorjahr		11.310,01		11.310,01	0,00	0,00
585	Sonstige Verbindlichkeiten		489,76		489,76	0,00	100,00
Summen		2.538.269,54	1.593.893,25	2.453.404,32	1.578.152,72	-69.124,69	-7,32
Gewinn / Gewinn		944.376,29		875.251,60		-69.124,69	-7,32
Summe Kontennachweis		2.538.269,54	2.538.269,54	2.453.404,32	2.453.404,32		

Seite 1 von 2 | FibuNet - Vorlage | Benutzer: <CB> | Server: <SRVDEV> | Port: 3645 | #20047 | v4.30 | #516

The comprehensive plausibility checks in the FibuNet financial accounting system ensure that balance sheets can be generated at short notice. Standard balance sheets are available at the push of a button with drill-down possible to the transaction level and with year-on-year comparisons over arbitrary periods of time.

“The collaboration with Fraunhofer IESE has made the strengths of the FibuNet software development explicit in a measurable form and has shown us where our architecture still has potential for improvement. We will systematically exploit this potential in order to validate the current quality characteristics and further increase the efficiency of the new FibuNet version. It is fun to collaborate with the IESE professionals on an equal footing.”

Ralf Graap, Dipl.-Informatiker and Chief Technology Officer at FibuNet GmbH

Further Reading:

Business Area Information Systems

p. 46

Division Information Systems p. 63



INTERNATIONAL ACTIVITIES

Fraunhofer IESE has a very strong international orientation. This is not only reflected in the fact that IESE currently employs staff from twelve different nations and that the language of the institute is English, but can also be seen in the growing number of international projects.

Fraunhofer IESE has established subsidiaries in the strategically important countries USA, Australia, and Brazil (called Centers):

- Fraunhofer Center for Experimental Software Engineering (CESE) at the University of Maryland, College Park, MD, USA (since 1998)
- Fraunhofer Project Center on Transport & Logistics at NICTA, Sydney, Australia (since 2010)
- Fraunhofer Project Center for Software and Systems Engineering in Bahia, Salvador, Bahia, Brazil (since 2012)

From the perspective of Fraunhofer IESE, these subsidiaries pay off for various reasons: additional competencies that we can in turn offer to our customers in Germany and in Europe; additional third-party industry project funds; and the acquisition of highly qualified staff. Examples of additional competencies are the development of the reverse engineering tool SAVE or the business alignment method GQM+Strategies®. An example of industry projects is the collaboration project with Campina Grande, Brazil, on the topic of medical devices. Personnel acquisition is currently most promising via our contacts in Brazil.

In the following, we present our subsidiaries and describe some selected international projects:

Fraunhofer Center for Experimental Software Engineering, Maryland (CESE)	107
Fraunhofer Project Center for Transport and Logistics in Australia	116
Fraunhofer Project Center on Software and Systems Engineering in Brazil	118
NUTES – Brazil’s Crash Test for Software in Medical Products	120
Business Alignment with GQM+Strategies® – Headed for Success with the Right Software and Information Strategy	122
MUNDUS – Multimodal Neuroprosthesis for Daily Upper Limb Support	124



Fraunhofer Center for Experimental Software Engineering, Maryland (CESE)

Director: Prof. Dr. Rance Cleaveland

The Fraunhofer Center for Experimental Software Engineering, Maryland (CESE) in College Park, Maryland, conducts applied research and technology transfer in software engineering processes and technologies. It collaborates with private-sector companies, government agencies, and academic institutions to develop innovative, useful approaches to address organizations' software development and management issues.

CESE has affiliations with the University of Maryland at College Park and the Fraunhofer Institute for Experimental Software Engineering (IESE) located in Kaiserslautern, Germany.

The Center's projects include a mixture of research efforts into new software technologies and empirical evaluations of existing tools and processes, and service-provision contracts to assist clients with software development or acquisition needs. Project customers include government agencies such as the Department of Defense, the US Food and Drug Administration, and NASA, and large multi-national companies such as Boeing and Robert Bosch. CESE also supports small and medium-sized companies with software needs in the Washington, D.C. – Baltimore, Maryland corridor.

Competencies

- Measurement and Knowledge Management
Contact: Dr. Forrest Shull
- Software Management and Process Improvement
Contact: Ms. Kathleen Dangle
- Software Architecture and Embedded Software
Contact: Dr. Mikael Lindvall
- Software Verification and Validation
Contact: Prof. Rance Cleaveland

Business Areas

- Aerospace / Defense
Contact: Kathleen Dangle, Frank Herman
- Automotive
Contact: Prof. Rance Cleaveland
- Medical
Contact: Dr. Mikael Lindvall

University Partners

- University of Maryland at College Park
- University of Maryland at Baltimore County
- Stevens Institute of Technology
- University of Kaiserslautern

Other Partners

- Axiom Resource Management, Inc.
- Johns Hopkins University Applied Physics Laboratory
- NASA IV&V Center



PROJECTS IN PROGRESS

Improving NASA's Space Communications Network

By conducting software research and infusing state-of-the-art software technologies and practices for the NASA Space Network (SN) Ground Segment Sustainment (SGSS) project, the Fraunhofer USA, Inc. Center for Experimental Software Engineering (CESE) is making key contributions to the future of the US Space Program.

The NASA Space Network (SN) is a communication signal relay system that provides tracking and data-transfer services between user platforms and user Mission Operations Centers (MOCs). The SN was established in the early 1980s to replace NASA's worldwide network of ground tracking stations and consists of a constellation of data relay and tracking satellites and associated ground systems. This space-based relay system can provide communication services over 100% of any customer platform orbit for altitudes ranging from 73 km to 9000 km, a capability that is unique within the civilian and commercial space industry. In addition, limited communication services can also be provided for customer platforms located on the ground and on ocean/sea surfaces (e.g., ships) as well as airborne platforms (e.g., atmospheric balloons). The fleet of Tracking and Data Relay Satellites (TDRS) in geosynchronous orbit serves as a data relay system between the SN ground system and the user platforms.

The SGSS system replaces a majority of the existing SN Ground Segment with modern technology and approaches to fulfill the following objectives with the highly available services that users of the SN have come to expect.

- 1) Monitor and control the SN Flight and Ground Segments; including management of the configuration, health, and safety of the TDRS spacecraft fleet and SN Ground Segment elements.
- 2) Provide SN user service planning and scheduling.
- 3) Relay user signals in forward and return directions between the ground and user platforms.
- 4) Distribute user data on the ground using NASA Integrated Services Network (NISN) services, user-provided networks, and local interfaces (LIs).
- 5) Provide tracking services for TDRS and user spacecraft.

The heart of CESE's 2011 SGSS research was the collection and analysis of software progress and quality metrics from the SGSS development contractors. Software progress metrics include measures such as requirements decomposed, requirements volatility, components designed, coded, and tested, etc. Software quality measures include defects found, defects corrected, etc. The analysis of these metrics permits CESE to identify areas of risk and opportunities for improvement of contractor outputs delivered to NASA. CESE also uses the metrics analysis to research new technologies and to infuse those that demonstrate risk reduction, better cost/schedule adherence, or software technology improvement into both the NASA Project Team and the SGSS development contractors. Specific technologies that CESE is researching include software cost and schedule estimation and tracking, software defect detection and reliability growth models, Service Oriented Architectures (SOA), and software metrics presentation techniques. An example of a software metrics dashboard that is used by the NASA SGSS Project Management Office to

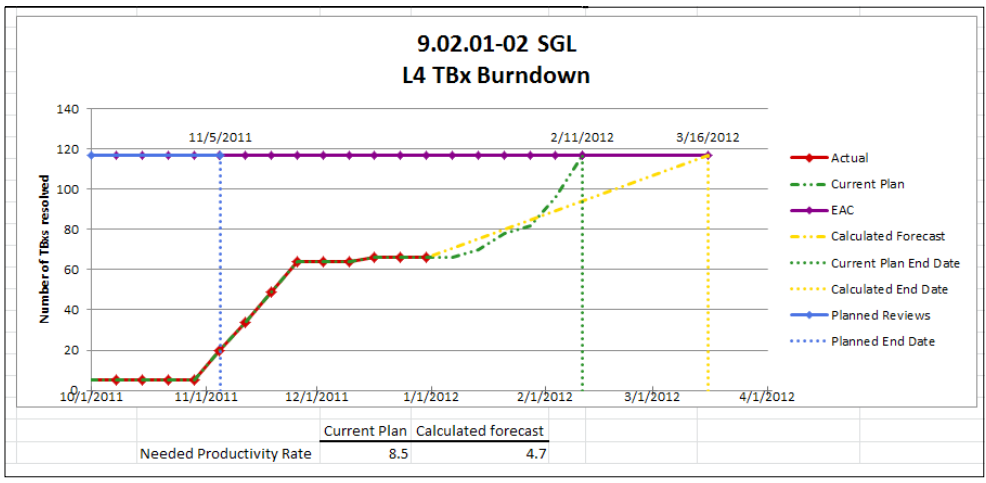

Sample Software Metrics Dashboard

evaluate the development contractor’s performance is shown above.

Of particular note is CESE’s research into mitigation of the risk associated with the use of Field-Programmable Gate Arrays (FPGAs) in the SGSS design. FPGAs are reprogrammable silicon chips that provide high performance, lower cost, and higher reliability than can be achieved with digital signal processors. Using prebuilt logic blocks and programmable routing resources, FPGAs can be configured to implement custom hardware functionality without having to physically develop any hardware. Digital computing tasks are developed in software and compiled to a configuration file that contains information on how the components on the FPGA should be wired together. In many ways, developing software for an FPGA is similar to traditional software applications; however, there are important, non-trivial differences in the development paradigm of FPGA software. These differences make traditional software techniques such as cost/schedule estimation,

progress tracking, and test coverage unworkable for FPGA software development, and little has been done in the FPGA community to develop techniques for FPGA software development. Due to the amount of FPGA code (>4.5M lines) used in the SGSS Digital Signal Processing element and the historic uncertainty of FPGA software costs/schedule estimation, etc., there is a huge risk to NASA that FPGA development will contribute to significant soft/schedule overruns and FPGA implementations with substantial fielded defects.

To mitigate this risk for NASA, CESE is conducting research to develop new techniques for estimating FPGA cost and schedule and new metrics for measuring and tracking FPGA development progress. These new techniques will enable CESE to advise NASA on the viability of the development contractor’s cost and schedule estimates and to provide NASA with accurate assessments of the development contractor’s performance early enough in the process to implement risk mitigations. CESE is also researching the application of CESE’s



traditional software test coverage analysis tools to the evaluation of FPGA software. Given that it is impractical to test every line of code and every logic path in the code, CESE's tool suite determines the most optimal test coverage that is necessary to achieve a high degree of confidence that the fielded software will be as defect-free as possible. The successful application of these tools and techniques to FPGA software, which is inherently complex and contains millions of logic paths, will help to ensure that SGSS will meet the 99.99999% availability requirements of the SN users.

The Fraunhofer Approach for Software Testing (FAST)

In 2011, Fraunhofer CESE received special funding from Fraunhofer USA to support the creation of the Fraunhofer Approach for Software Testing (FAST). FAST is now a method for testing software from many domains, including aerospace, medical devices, and web software. Highlights during the year included the following:

- 1) CESE developed technical collateral, including a model-based software testing architecture, a "design for testability" knowledge base, reusable testing models, and a testing process and best practices. These assets constitute the main intellectual property for Fraunhofer and are already being used in several third-party projects.
- 2) By applying the FAST on CESE NASA test-beds, Center researchers were able to detect several previously unknown critical issues in these systems as well as several improvements of the FAST. These testing projects were documented and used as tutorials and presentations to demonstrate the capabilities to interested parties.
- 3) Center staff used the FAST to test several commercial software systems, resulting in different types of detected software errors. CESE clients are typically unhappy about their current testing process due to high cost and effort and uneven quality. Using the FAST, software may be improved for testability and then systematically tested because of the structured approach to software testing it facilitates.



The FAST is based on two fundamental technical principles. The first is Design for Testability: Based on extensive experience in working on large-scale software systems, CESE staff members have collected an informal corpus of knowledge encompassing principles that are used by the best software engineers at NASA and JHU/APL to enhance the ease of testing software. These best practices dramatically improve the testability of the final product. For example, instead of the software making direct use of a data source, a best practice is to encapsulate the data source with a wrapper and an interface, which the software then uses. Testing is now facilitated because the real data source (e.g., an SQL database) can be replaced by a testing stub without the software’s knowledge. CESE has formalized this corpus of knowledge in order to better help our partners with their software testing.

The second technical foundation for the FAST is Model-based Testing (MBT). MBT is an exciting new technology developed in the research community that has attracted attention among practitioners. In MBT, tests are specified as abstract, programming-language-independent models. A translator maps abstract test specifications to concrete tests. The advantages of this approach are as follows:

- 1) Such test models are insulated from changes in the source code, thus radically reducing maintenance costs.
- 2) One creates a test specification only once in terms of a model and executable test cases are automatically generated without programmer intervention.

- 3) Models are much easier to understand than code for humans and allow all stakeholders to understand how the SUT is being tested.
- 4) Tests automatically generated from behavioral models cover aspects of system behavior in a much more complete manner compared to manually written tests.

Center staff published and presented the results of the FAST project in several venues, including technical conferences and workshops aimed at software-testing practitioners. The full list for 2011 includes:

- 1) Dharmalingam Ganesan, Mikael Lindvall, Christoph Schulze, Gunnar Vortes, David McComas, et al. Automated Test Generation of Flight Software. Workshop on Flight Software, JHU/APL, 2011.
- 2) Dharmalingam Ganesan and Mikael Lindvall. Automatic Test Generation the FAST Way. Verify/ATI Test Automation Conference, 2011.
- 3) Dharmalingam Ganesan and Mikael Lindvall. Software Product Lines - Technological and Economical Aspects. INCOSE, Chicago chapter, 2011.
- 4) Mikael Lindvall and Dharmalingam Ganesan. Automatic Test Case Generation and Parallel Test Case Execution. A whitepaper, Fraunhofer CESE, 2011.
- 5) Mikael Lindvall and Dharmalingam Ganesan. Automatic Generation of Test Cases. Webinar May 16, 2012, Organized by the IT Metrics & Productivity Institute, <http://www.itmpi.org>



Medical-Device Industrial Software

CESE has established a new contract with a major medical-device manufacturer (“Company”) to analyze the effectiveness of its software development practices. Company is a distributed organization that includes many subsidiary organizations around the US and the world making a variety of medical equipment, including wearable medical devices as well as those used in laboratory, clinical, and diagnostic settings. Like many other modern devices, these products are often controlled by software, making software a very important, but almost invisible, part of the device. It is well known that software can also contain defects, and it is of course important that these are removed before the medical device is deployed into the field and used by human beings. Mature medical device manufacturers like Company already have stringent software quality processes in place that ensure the quality of their products. In addition, the Food and Drug Administration (FDA) regulates the development of medical-device software especially from a safety perspective, which adds scrutiny to the process. However, the software industry is very fast-paced, and the introduction of new software technologies as well as the increasing complexity of products based on software call for constant search for best practices that can improve current processes.

The CESE project is devoted to establishing a software inventory of best practices across several subsidiary organizations in Company. The first step was to develop a set of questions that touch upon the most important aspects of software development for medical devices. This analysis resulted in 17 topic areas such as project management, requirements engineering, reliability engineering, software architecture, and software testing. Two CESE scientists then visited different sites in the

USA and conducted interviews with the different people who are involved in software development for medical devices.

The results from this project include an impressive list of best practices related to software development, defect-mitigation strategies, and subcontractor management practices.

Systems Engineering Research

Through participation in the Systems Engineering Research Center (SERC), Fraunhofer CESE is addressing key research priorities of the US Department of Defense. The SERC is one of the 13 university-affiliated research centers in the US Department of Defense (DOD) and brings together the research and expertise of senior researchers in systems engineering from 20 collaborator universities and not-for-profit research organizations throughout the United States.

In one project begun in 2011, CESE is working to unify the models, represented in a variety of software databases and applications, that are used for aspects of DOD planning, deployment, and operations. Currently, each model captures the behavior of only a subset of technical areas. When conditions or needs change, replanning is a challenge because of the diversity of models and technical areas. Fraunhofer CESE’s efforts are focused on unifying the multiple models to identify dependencies between key constraints. Fraunhofer scientists are eliciting knowledge from model experts within the DOD, coding and analyzing this knowledge, and refining the resulting models. Once these dependencies are clearly articulated, we will develop improved processes for communication and planning among stakeholders.



A second CESE project is motivated by the recognition of the growing importance of cloud computing as an emerging technology paradigm. The increasing prevalence of cloud computing technology is already starting to affect the field and discipline of system engineering, with a potentially transformative effect on systems as well as on the systems engineering discipline. Cloud computing gives access to virtually limitless resources for even small portable devices with minimal local computing power. CESE's work is exploring new technologies and trends that will impact system engineering, as well as the changing skillsets that are required for effective system engineers.

GQM+Strategies®

Scientists from Fraunhofer CESE applied the GQM+Strategies® methodology in a project at a non-profit organization that manages federally funded research and development. The goal of the project was to define a new experience-sharing portal which would be used to share best practices and improve government efficiency across multiple agencies. The GQM+Strategies® methodology was applied in order to define a feasible technical focus and business strategy for the development of the new system, incorporating information and constraints from a large number of stakeholders. GQM+Strategies® was designed to handle exactly this issue, namely, connecting the business goals from multiple and diverse stakeholder sets to specific technical approaches. This project provided two unique opportunities. First, it demonstrated the versatility of the methodology, since GQM+Strategies® was applied for the first time as a means

for selecting a business strategy from among multiple options. Second, being applied at a non-profit organization with a unique business model, the project offers insights into an original set of business drivers apart from the usual set of market share, profit/revenue, or customer satisfaction.

Fraunhofer CESE continues to collaborate with Fraunhofer IESE to refine the GQM+Strategies® methodology, and more importantly, to package the technology so that it can be used to improve staff efficiency in the measurement-related project work that is a core capability for both CESE and IESE. The collaboration continues to build a unique and marketable Fraunhofer capability, which will address one of our organizations' business areas and facilitate projects at both CESE and IESE. Both CESE and IESE have developed a set of assets that are reusable for both centers, including: a training course for use with customers and collaborators, a process description, a tool for visualizing the GQM+Strategies® outputs, and case studies – all of which stem from the knowledge, experience, and expertise resulting from the various engagements between CESE and IESE with customers.



InViz: Instant Visualization of Cybersecurity Attacks

The growing number of attacks on cyber networks has become, in President Obama's words, "one of the most serious economic and national security threats our nation faces" [1]. Tool and research support in the area of cyber forensics is in high demand.

Scientists at Fraunhofer CESE have created an initial research prototype called InViz – Instant Visualization of cybersecurity attacks. InViz enables human experts as well as novices to identify cybersecurity attacks by means of novel information visualization techniques. InViz is an easy-to-use tool that allows users to observe network traffic in real-time. The focus of CESE's ongoing research is to understand how to effectively

present information to enable efficient identification of attack patterns in the large amounts of data typically produced by today's network devices.

The current prototype tool is proving to allow quick detection of different attack patterns, such as denial of service attacks (an attempt to make the target computer unresponsive), backdoor exploits (an attempt to use known security leaks in installed server software), and vulnerability scanners (an attempt to identify specific weaknesses of network devices and servers, such as open ports).

[1] Department of Homeland Security, Cybersecurity Website, <http://www.dhs.gov/files/cybersecurity.shtm>, accessed 1/6/2012.





CESE in Figures

CESE experienced some contraction in its revenues in 2011 vis à vis 2010. This was due to significant turmoil in the US Federal budget; the government nearly suspended all non-essential activities early in the year due to the national legislature’s inability to agree on funding priorities. Three of CESE’s largest projects were canceled as a result. However, the Center is not expected to show a loss for the year, due to aggressive cost-containment measures that Center management implemented after the project cancellations.

Important new project wins included various efforts in the medical-device sector, both industrial and governmental; research projects through NASA’s Software Assurance Research Program; and new research efforts in cybersecurity and dataming of social computing websites for law enforcement purposes. At the time of this report, final year-end figures for CESE were not available, but projections based on data through November 2011 suggest that third-party revenues will be approximately 10% lower than those of 2010. These should rebound somewhat in 2012.

Total revenues (in T US dollars).

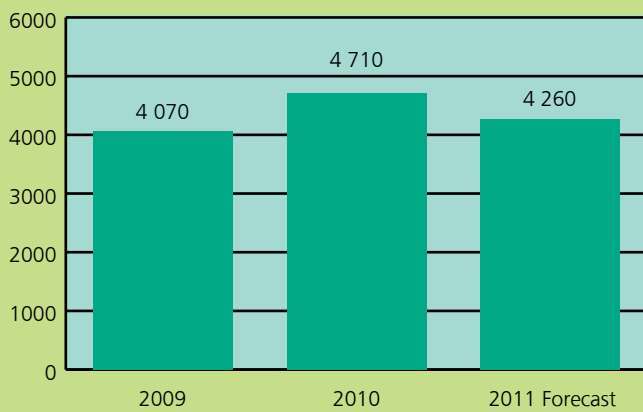

Third-party revenues (in T US dollars).

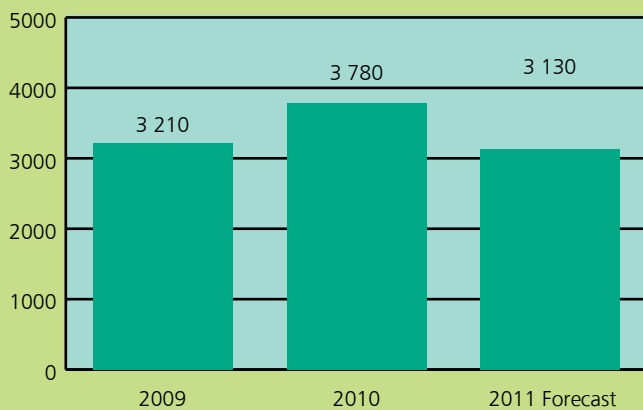

Retained earnings (in T US dollars).

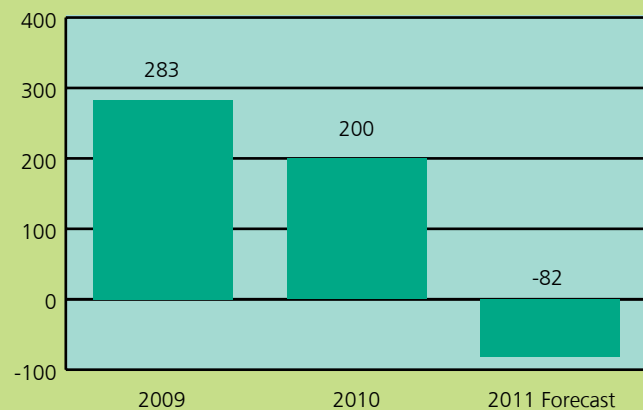

Fraunhofer Project Center for Transport and Logistics in Australia

Director: Dr. Glenn Geers, NICTA

Deputy Director: Dr. Christian Webel, Fraunhofer IESE

Contact

Dr. Christian Webel
 Phone +49 631 6800-2185
 Fax +49 631 6800-9 2185
christian.webel@iese.fraunhofer.de



Dr. Christian Webel

Since May 2010, the Fraunhofer Project Center for Transport and Logistics at the “National Information and Communication Technology Research Centre of Excellence, Australia (NICTA)”, under the leadership of Dr. Glenn Geers and in cooperation with Fraunhofer IESE, has been offering research and consulting services in the area of information and communication technologies (ICT) for logistics and intelligent transport management. The Fraunhofer Project Center is an important address for the Australian transport and logistics industry.

As a special highlight, the Future Logistics Living Lab was officially opened on 23 February 2011 together with SAP Research Australia. Its goal is the prototype realization of innovative systems, products, and processes in the area of logistics, and first results of these research collaborations (which have been ongoing since 2010) are already available. The number of partners of the Living Lab has increased since the opening from eight to currently 22. Altogether, three joint projects were started in 2011 and a total of six customer workshops were held. As far as dissemination is concerned, there were more than ten publications in professional logistics magazines and journals. Overall, the Living Lab counted more than 700 visitors, including high-level government and business delegations, such as the Minister of Science and Technology of the People’s Republic of China, Dr. Wan Gang, as well as several delegations from the Australian and German parliaments.

Further Information

Homepage of the Living Lab
www.futurelogisticslivinglab.com



Furthermore, two additional research collaborations were launched in 2011. In cooperation with Australian researchers from the NICTA institute, Fraunhofer IESE is working on the development of a domain-specific language for the elicitation and specification of logistics-related requirements. Nowadays, consultants and analysts in the logistics field generally use their own experience, respectively that of their company, as a basis for developing novel ideas and adaptations for current and future logistics processes and applications. This includes, in particular, processes from the areas of fleet management, dynamic route planning, or load resp. capacity optimization. In these areas, it is necessary to elicit existing logistics data from the customer, package it, and analyze it using existing mathematical algorithms. The results are then integrated into new solutions in the best possible way. Success or failure strongly depends on the quality and relevance of the results regarding the customer’s needs. In a first step, the domain-specific language will support analysts and consultants in eliciting and assessing existing needs and constraints together with their customers. To do so, the language will provide a framework for eliciting all necessary information, while also offering a selection of notations that the customer can comprehend. In a second step, the language and the underlying framework will guide analysts through the systematic derivation of needed services and solutions and thus result in the systematic identification of the algorithms that are relevant for the analysis.



The Future Logistics Living Lab in Sydney, Australia

This will result in much closer alignment of future evaluation opportunities and result data with the original customer needs. On the one hand, logistics companies will thus get better support for their decision-making processes from more accurate evaluations, while analysts and consultants, on the other hand, will be enabled to systematically evolve their existing algorithms and processes on the basis of real customer needs.

A further research project between NICTA and Fraunhofer IESE aims to investigate the effect of Cognitive Load on User Experience in a driving simulator. The project is motivated by the fact that both Cognitive Load and User Experience are understood to be critical in the automotive domain but little evaluation has taken place in this domain. For this purpose, NICTA and Fraunhofer IESE plan to conduct a controlled experiment in a driving simulator to investigate research questions like: (1) Is there a relationship between CL and UX? (2) If so, how strong is this relationship? (3) Does this relationship evolve or change over time, especially regarding different driving situations (easy, moderate, hard), different user interfaces (UIs) (graphical or tangible UIs), or different input methods (speech, touch) for interacting with a device in a car (e.g., navigation system)? In order to investigate these research questions, the first challenge to be solved is related to the design of such an experiment, in particular how to manipulate and measure these “human-oriented” variables CL and UX in a driving simulator.

Collaboration Partner

NICTA
<http://www.nicta.com.au/>



Further Reading:

Business Area Automotive and
Transportation Systems p. 40
Division Information Systems p. 63

Fraunhofer Project Center on Software and Systems Engineering in Brazil

Director: Prof. Dr. Manoel Mendonça, UFBA

Deputy Director: Dr. Karina Villela, Fraunhofer IESE

Contact

Dr. Karina Villela

Phone +49 631 6800-2173

Fax +49 631 6800-9 2173

karina.villela@iese.fraunhofer.de



Dr. Karina Villela

In 2011, Fraunhofer IESE and the Federal University of Bahia (UFBA) in Brazil worked on a sound business plan for the Fraunhofer Project Center on Software and Systems Engineering at UFBA. UFBA is the leading university in the State of Bahia, which is very active in the area of software engineering. Its Software Engineering Laboratory (LES) has eleven researchers with PhD degrees, who have published close to 300 papers in the last five years (<http://les.dcc.ufba.br>). In recent years, researchers from LES participated in several R&D projects with the energy, health, and IT industries.

The goal of the Fraunhofer Project Center at UFBA is to expand LES's activities in order to not only produce relevant research results and provide high-level education, but also to act as a strong source of new technologies and solutions to the industry inside and outside the country. The cooperation between LES and Fraunhofer IESE will enable, facilitate, and accelerate the development of innovative solutions for the Brazilian industry. Examples of technical areas in which LES/UFBA and Fraunhofer IESE intend to collaborate are:

- Software engineering processes, methods, and techniques for critical and/or large systems
- Maintenance, evolution, and reengineering of critical and/or large systems
- Decision support and critical systems for the energy industry (oil, gas, and electricity)
- Open-source software for eGovernment and for suppliers' product and process certification
- Software technologies for ambient assisted living and large-scale field studies
- Mobile business applications

In order to implement a successful Fraunhofer Project Center, several work packages have been defined:

Competence development and technology transfer in Engineering: The goal is to support the efficient development and maintenance of software and systems in the aforementioned technical areas. To this end, the following relevant tasks have already been identified: 1) reuse infrastructure and variation management, 2) modularity, architecture, and evolution, and 3) development of mobile applications and context-sensitive systems.



Competence development and technology transfer in Quality: Here, the goal is to support customer companies in assuring the quality of their software processes and products, or even the quality of third parties' processes and products. The corresponding tasks will be: 1) software process improvement and assessment, and 2) quality assessment of software products and components.

Demonstration and dissemination of competencies in a business-oriented way, which will pursue two of the following initiatives: 1) creation of courses and trainings in software and systems technologies, 2) establishment of an ICT demonstration laboratory, or 3) establishment of a competence center on open software. Courses and trainings, carried out either in a traditional way or based on eLearning, have great potential because many professionals in Brazil are willing to obtain further education after the end of their studies. The decision about whether to establish an ICT Demonstration Laboratory or an Open Source Competence Center will depend on market opportunities and industry interest.

Additional work will include establishing the Fraunhofer Project Center as such, as well as continuous project acquisition and management activities.

The Fraunhofer Project Center at UFBA is open in the sense that other universities across Brazil may be considered as associated partners. Furthermore, associated partners could eventually become members. In this sense, the University of Sao Paulo in the city of Sao Carlos (USP/SC) has already expressed its willingness to join the initiative and contribute its expertise in critical embedded systems.

The opening ceremony of the Fraunhofer Project Center at UFBA took place on 09 March 2012, in the presence of the Executive Director of Fraunhofer IESE, Prof. Rombach, the Lord Mayor of Kaiserslautern, Dr. Klaus Weichel, and various representatives of businesses from Kaiserslautern.

NUTES – Brazil’s Crash Test for Software in Medical Devices

Contact

Sören Kemmann

Phone +49 631 6800-2218

Fax +49 631 6800-9 2218

soeren.kemmann@iese.fraunhofer.de



Sören Kemmann

The Brazilian partner in this project is the State University of Paraíba (UEPB). Since 2008, the university, in a partnership with the Brazilian Ministry of Health, has been investing in the creation of a regional center of Biomedical Engineering. This action is part of a major project of the Brazilian Federal Government regarding the promotion and development of the Brazilian Health Industrial Complex and the design of a new legal and institutional framework to support technological innovation on strategic devices and improve local competencies. The acronym “NUTES”, which may not sound very scientific at first glance, stands for “Núcleo de Tecnologias Estratégicas em Saúde”, meaning “Center for Strategic Technologies in Health Care”. The establishment of this center is being funded by the Brazilian government. The choice of location fell on Campina Grande in the State of Paraíba in order to improve the rather weak local economic situation. The goal is to improve the quality of software-intensive medical devices. This goal also envisions that the center shall perform the certification of software-intensive medical devices.

In Brazil, the certification of medical devices was already introduced by the Brazilian Ministry of Health in 1993. Since then, the expected maturation of product quality in hardware development has improved significantly. However, this process is only in the early stages as far as software as an integral component of modern medical devices and, subsequently, the quality assurance and quality evaluation of software are concerned.

From a standards point of view, adherence to processes is required; “however, the safety of the software and/or the software-intensive medical device is only ensured insufficiently by this”, says Soeren Kemmann, manager of the project at Fraunhofer IESE. He explains this using an analog process in mechanical engineering: “If this approach were to be used in mechanical engineering, then a standard would prescribe, for example, that you must pay attention to stiffness when constructing a chassis, and document this, but nothing else! A Word document proving that one has considered everything (in a qualified manner) would be sufficient.” Thus, there would be no crash test or test drives: unimaginable in mechanical engineering.

“We are thus developing a crash test for software in medical devices!”



Such a crash test for software is a desirable goal, not only in Brazil. In Germany, too, there is no established process for checking software as a whole similar to a crash test. This also leads to issues to be investigated by science:

- What is software quality?
- What are criteria that can be checked and proven?

This is the area where Fraunhofer IESE can optimally leverage its many years of experience in software engineering. For Fraunhofer IESE as an independent institution that has already authored several expert reports about large software systems, e.g. for court cases, this is an ideal task. In addition, the role of the Fraunhofer-Gesellschaft as a transfer organization between science and business is also leveraged in the best possible way. Thus, we are not only able to answer the scientific challenges in a competent manner, but we can also answer the “how” of practical application in addition to the “what” of scientific research:

- How do I actually check quality?
- How can I assess the criteria?

It is obvious that here we have a task in the spirit of Fraunhofer. The context of realizing it in Brazil is also custom-tailored, so to speak, for an internationally oriented institute such as Fraunhofer IESE.

“The partnership and technical cooperation with Fraunhofer IESE will allow Brazil to quickly, objectively, and within a short period of time absorb knowledge and methodologies that are necessary for the development and evaluation of embedded software in medical devices.”

Prof. Dr.-Ing Misael Morais (UEPB), NUTES project leader in Brazil

Collaboration Partners

State University of Paraíba
<http://www.uepb.edu.br>

Brazilian Innovation Agency
<http://www.finep.gov.br>

Brazilian Ministry of Health
<http://www.saude.gov.br>



Further Reading:

- Business Area Medical Devices p. 44
- Division Embedded Systems p. 55

Business Alignment with GQM+Strategies® – Headed for Success with the Right Software and Information Strategy

Contact

Dr. Adam Trendowicz
 Phone +49 631 6800-2193
 Fax +49 631 6800-9 2193
adam.trendowicz@iese.fraunhofer.de



Dr. Adam Trendowicz

Software-intensive systems and services are becoming increasingly important in today's information society and thus constitute a central driver for innovation and growth in an organization. One of the consequences is that business success depends on IT and software strategies and that it is extremely important for an organization to look at these strategies in the context of the business goals pursued and to align them accordingly across the entire organization. This comprises the systematic derivation of IT and software strategies from business goals on the one hand and the ability to clearly demonstrate the contributions made by IT and software development to the business goals on the other hand.

In order to address these issues and to provide systematic support for "Business Alignment", the GQM+Strategies® approach has been developed in recent years. This approach uses goal-oriented measurement processes to support the explicit alignment of goals and strategies across all levels of an organization. Goals, strategies, and measurement data are systematically aligned with each other, gaps and inconsistencies are shown, and the derivation of action recommendations is facilitated by means of a decision model.

Since 2009, the Japanese Information-technology Promotion Agency, Japan (IPA) has been transferring the GQM+Strategies® approach to software organizations in Japan. IPA is a Japanese government agency established for the purpose of transferring innovative information technologies into the Japanese industry. In particular, the activities of IPA focus on (1) assuring the security and reliability of social IT services and systems, (2) strengthening international competitiveness, and (3) cultivating highly skilled world-class IT human resources. The Software Engineering Center of IPA (IPA/SEC), in collaboration with Fraunhofer IESE, has been promoting the GQM+Strategies® approach through multiple seminars and workshops followed by GQM+Strategies® application initiatives performed within individual software organizations.

Several applications of GQM+Strategies® at various software organizations have shown that its use can noticeably improve the transparency, availability, and measurability of strategies and goals:

- Transparent description and harmonization of goals, strategies, and measurement data across all organizational levels.

Collaboration Partner

Information-technology
 Promotion Agency, Software
 Engineering Center
www.ipa.go.jp/index-e.html



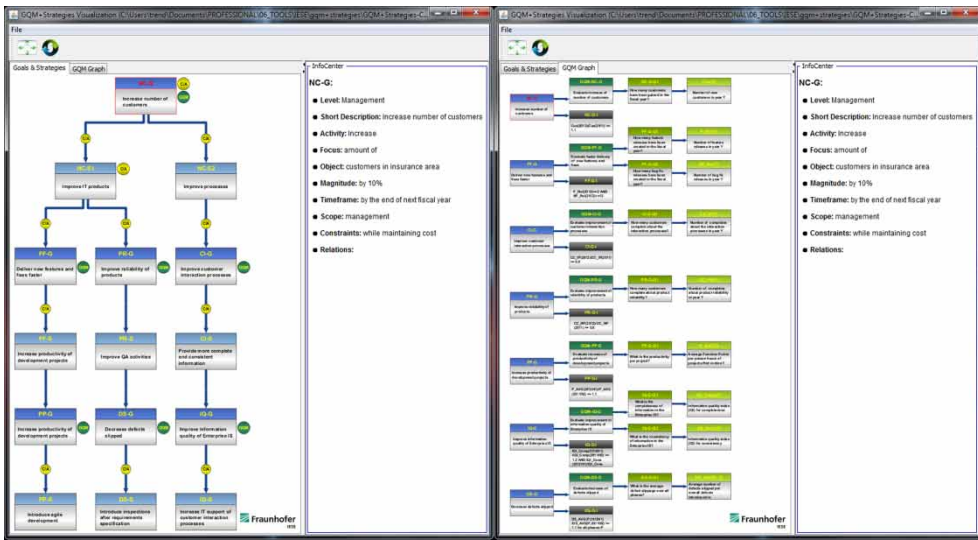
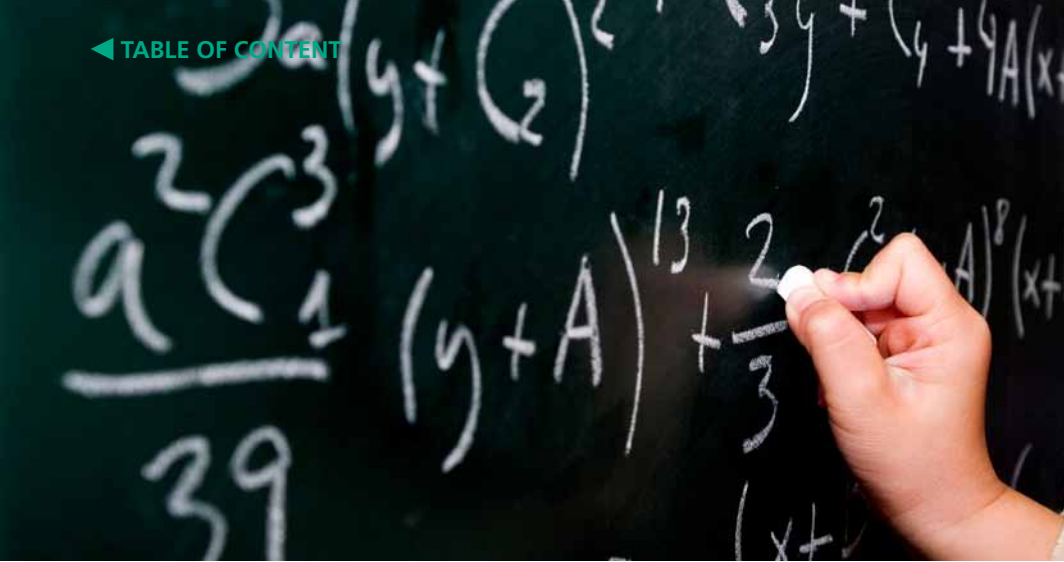

The GQM+Strategies® visualization tool is used interactively in workshops to model the relationships between an organization's goals and strategies and their success and to assess them by means of measurement data.

- Clarification of the value contributed by IT and software development in terms of the organization's business goals.
- More consistent communication of goals and strategies across all organizational levels.
- More objective decision making by measuring the achievement of goals and the success/failure of strategies.
- Clear rationale why goals and strategies are pursued.

The GQM+Strategies® approach supports a number of different application scenarios. For example, the method was applied in the context of insurance companies where it addressed two purposes:

- Identifying IT strategies for expanding insurance services to new domains.
- Selecting from a large number of project proposals a subset of projects (project portfolio) that was optimal with respect to the trade-off between their contribution to organizational business goals and their cost (total project budget).

Further Reading:

Business Area Information Systems
 p. 46
 Division Process Management p. 59

MUNDUS – MULTImodal Neuroprosthesis for Daily Upper Limb Support

Contact

Dr.-Ing. Andreas Jedlitschka
Phone +49 631 6800-2260
Fax +49 631 6800-9 2260
andreas.jedlitschka@iese.fraunhofer.de



*Dr.-Ing. Andreas
Jedlitschka*

Further Information

Project Homepage
www.mundus-project.eu



Funded by the European Union:
MUNDUS EU-FP7 ICT-4-7.2 –
Accessible and Assistive ICT,
GA # 248326



Assistive technologies are intended to enable people with impairments to live independent lives. Most solutions to support people with severe motor impairments completely substitute their natural interaction with the world, which is an obstacle to the acceptance of such solutions. In terms of human dignity and self-esteem, however, missing motor functions rather need to be restored with the help of assistive technologies, and support should only be provided to the extent necessary. Nine European organizations, including universities, research institutes, companies, and a hospital, each with outstanding competencies in their respective field, have bundled their expertise in the EU project MUNDUS (**MULTImodal Neuroprosthesis for Daily Upper Limb Support**) to research and develop an assistive framework that shall provide support for arm and hand functions in order to help severely motor-impaired people recover the ability to interact independently with their environment.

The central element of MUNDUS is the MUNDUS controller, which integrates multimodal information collected via electromyography, bioimpedance, head/eye tracking, and brain-computer interface commands and uses this information as input for the actuators. Any residual control the end-user may still possess is used as input by MUNDUS, so that an activity is supported minimally, but optimally. The MUNDUS actuators modularly combine a lightweight and non-cumbersome exoskeleton – a biomimetic wearable neuroprosthesis for arm motion – to compensate for the weight of the arm and a mechanical construction to assist a person in grasping an object. Light weight and easy handling are crucial factors in terms of the solution's applicability in home/work environments. Specific scenarios in home and work environments will be used for the subjective and quantitative assessment of the system's usability by real end-users.

The expertise in neuroprosthesis design, motor control, motor learning simulations, and motion analysis of the Bioengineering Department of **Politecnico di Milano** (Italy) contributes to the design of a biomimetic controller and stimulation strategies for a Neuromuscular Electrical Stimulation (NMES) system, the simulation of motor control for arm movement trajectory planning, and the integration of an eye-tracking system as one of the user interfaces. Another user interface is a brain-computer interface being developed by the Brain-Computer-Interface Group at the **Technical University of Berlin (TUB)**. The Control Systems Group at TUB is implementing the control of the actuators and the muscles in a real-time system. The Research Group for Machine Elements and Rehabilitation Engineering within the Department of Engineering Design and Logistics Engineering at **Vienna University of Technology** (Austria) contributes to the design of the lightweight exoskeleton, applying lightweight materials and lightweight construc-



tion concepts. In addition, specific dampers and actuators based on magnetorheological fluids will be developed. The Automatic Control Laboratory of the **Swiss Federal Institute of Technology Zurich** (Eidgenössische Technische Hochschule Zürich) contributes its competencies for the development of a wearable system to deliver functional electrical stimulation and for the algorithms to elicit motor function to achieve functional grasping.

The involved companies are specialists in rehabilitation. Based on its existing products, **Hocoma** (Switzerland) has competencies regarding the development of a lightweight exoskeleton. Also, as one of the main exploitation partners, they support the adaptation and integration of newly developed technologies into a working system to be used for clinical evaluation. Hocoma will also take care of the market-oriented implementation of the technologies and certification with regard to commercialization. The second company, **Ab.Acus** (Italy), contributes its competencies in the area of interactive products. **CF Consulting** (Italy) is responsible for the administrative part of the project management.

Valduce is an Italian hospital experienced in experimenting with advanced ICT technologies for medical applications; it will provide the environment for evaluating MUNDUS with real end-users.

Fraunhofer IESE is working especially on the integration of unobtrusive sensors into the overall system. Imaging sensors as well as sensors for measuring distance are used. The combined data from these sensors continually provide information about the relevant positions of the assisted person's upper torso as well as about the objects located in this person's work environment. The positional information is used by the system to plan the movement to be executed and, if needed, to correct it in real time.

Furthermore, Fraunhofer IESE is developing an evaluation framework that will be used to systematically examine the effectiveness of MUNDUS in the field. In this context, a graphical user interface is being developed that shall enable the attending physician or nurse to assess the quality of the movement. To realize this interface, an appropriate assessment schema is being designed and implemented in close cooperation with the doctors involved. The empiricism team of Fraunhofer IESE will make major contributions to the development of the evaluation plan, i.e., the description of the process for systematic evaluation, as well as to the development of appropriate measurement instruments, such as a questionnaire for determining the acceptance of MUNDUS by patients.

Collaboration Partners

Politecnico di Milano
<http://www.biomed.polimi.it/nearlab/>

Technical University of Berlin
<http://www.tu-berlin.de/>

Vienna University of Technology
<http://www.tuwien.ac.at/>

Swiss Federal Institute of Technology Zurich
<http://www.ethz.ch/>

Ospedale Valduce - Congregazione delle Suore Infermiere dell'Addolorata
http://www.valduce.it/h_congregazione.htm

Ab.Acus srl
<http://www.ab-acus.com/>

Hocoma AG
<http://www.hocoma.com/>

CF Consulting Finanziamenti Unione Europea srlC
<http://www.cf-consulting.it/>

Further Reading:

Business Area Medical Devices p. 44

Division Process Management p. 59



CONTACT

How to find us	128
Fraunhofer IESE Contact Persons	132
Information Service	135

HOW TO FIND US

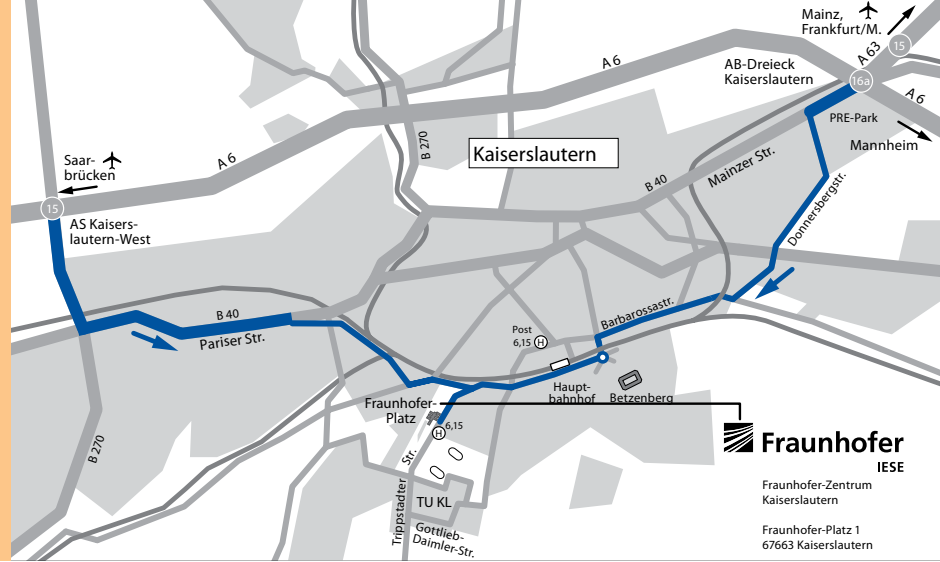

Fraunhofer-Institut für Experimentelles Software Engineering
 Fraunhofer-Platz 1
 67663 Kaiserslautern
 Germany
 Phone +49 631 6800-6000
 Fax +49 631 6800-1099
www.iese.fraunhofer.de

By car

Coming from the West on Autobahn A6, take the exit Kaiserslautern-West (15), then go towards downtown and follow the signs towards the university. Before you get to the university, you will reach the building complex of the Fraunhofer Center a few hundred meters down Trippstadter Strasse, on the right side of the street.

Coming from the East on Autobahn A6, go to the Autobahn Interchange (“Autobahndreieck”) Kaiserslautern, and take the exit Kaiserslautern-Centrum (16a). Then first follow the signs towards Betzenberg Soccer Stadium, then towards the university. It is best to use the detour behind the train station via Zollamtstrasse; at the end of the street, continue straight ahead into Trippstadter Strasse. The building complex of the Fraunhofer Center is located approx. 500m down the street on the right side.

Getting there by means of electronic navigation:

Since most likely, the Fraunhofer-Platz is not yet listed in most electronic navigation systems, we recommend using “Trippstadter Strasse 125” as the destination instead. The Fraunhofer Center is located directly across the street..

By rail and bus

Proceed to the main train station, Kaiserslautern Hauptbahnhof, and then either take a taxi or take TWK city bus no. 106 (towards Mölschbach) or no. 115 (towards Universität), getting off at the stop “Fraunhofer-Zentrum”.

By air

From Frankfurt Rhein Main Airport, either by train (approx. 2 hours) or by rental car (approx. 1.5 hours).

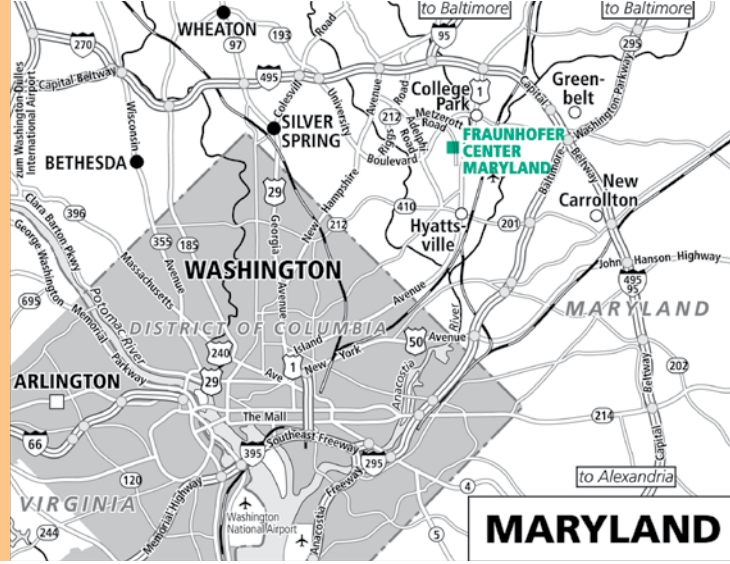

Fraunhofer USA Center for Experimental Software Engineering
 5825 University Research Court
 Suite 1300
 College Park, MD 20740-3823
 USA
 Phone +1 240 487-2905
 Fax +1 240 487-2960
 www.fc-md.umd.edu

By Car

Directions from the North

Take Interstate 95 (I95) South (East part of Washington Beltway, I495). Take Route 201, Kenilworth Avenue exit. At the end of the exit ramp, go right. Continue past the light for Paint Branch Parkway / Good Luck Road through one more light. Turn right at light for River Road. After crossing over a small bridge, turn right onto University Research Court. Our building is at the end of University Research Court on the right. Go in the front doors in the center of the building. We are on the first floor, past the elevators, and to the left.

Directions from the South – traveling northbound on Interstate 95 (I95)

Take I95 North to the Washington Beltway – I 495, going North or towards College Park. Take the exit for Route 50, going west, towards Washington, DC. Take the exit for Route 410, Veterans Highway. At the end of the exit ramp, go right. Continue on 410, crossing through the traffic light at Route 450. The road will come to a “T”, turn left, following the signs for 410. You will pass under the Baltimore/Washington Parkway and through several lights.

At the light for Route 201 Kenilworth Avenue, turn right. Turn left onto River Road. After crossing over a small bridge, turn right onto University Research Court. Our building is at the end of University Research Court on the right. Go in the front doors in the center of the building. We are on the first floor, past the elevators, and to the left.

Directions from the Washington, DC area

Take DC-295 North, following signs for the Baltimore/Washington Parkway. Exit at Riverdale Road/Route 410, turning left onto Riverdale Road, which becomes East-West Highway. Go to Route 201 Kenilworth Avenue and turn right. Turn left onto River Road. After crossing over a small bridge, turn right onto University Research Court. Our building is at the end of University Research Court on the right. Go in the front doors in the center of the building. We are on the first floor, past the elevators, and to the left.



Fraunhofer Project Center on Transport and Logistics
 NICTA (National ICT Australia), Sydney
 ATP Research Laboratory & Corporate Head Office
 Australian Technology Park,
 Level 5, 13 Garden Street
 Eveleigh NSW 2015
 Australia

www.nicta.com.au

Main Phone: +61 2 9376 2000

Main Fax: + 61 2 9376 2300

By Car

The entrance to the Australian Technology Park car park is from Henderson Road, Eveleigh. A Pay and Walk ticketing system has been installed for your convenience. Collect a ticket from the boom gate and drive through to the car park located on ground floor of 8 Central Avenue (Media City Building).

Event/ Visitor car parking is available at 8 Central Ave (Media City Building). Collect a ticket from the boom gate and drive through to the Car Park, located at Ground Floor, 8 Central Ave.

By Rail

CityRail operates frequent train services between Redfern Station (adjacent to the Australian Technology Park) and other major Sydney stations including Central, Town Hall, Wynyard and Circular Quay.

For information about travelling by rail, including timetable information, call the Transport Infoline on 131 500 or visit www.131500.com.au

From Redfern Station

Exit via Platform 10 at Redfern Station. Walk past the WaterTower apartment block and follow the walkway through to the Australian Technology Park. Pedestrian access to the Locomotive Workshops are through Bays 1, 4 and 8. For information relating to specific building and tenant location, enter through the side door of Bay 1 and proceed to ATP Precinct Management offices, located on Level 1/Bay 4 Atrium or phone (02) 9209 4220 for further assistance.

By Bus

There are frequent bus services to the Australian Technology Park from the city and Sydney's domestic and international airport. The bus stop closest to the Australian Technology Park is on the corner of Boundary and Regent Street. For bus timetables call the Transport Infoline on 131 500 or visit www.131500.com.au .



Fraunhofer Project Center for Software and
Systems Engineering
Parque Tecnológico de Salvador
Avenida Luiz Viana Filho
Loteamento Colinas do Jaguaribe, Lote M
Salvador, Bahia,
Brazil

Contact
Prof. Dr. Manoel Mendonça
Phone: + 55 71 3283-6343
Email: mgmendonca@dcc.ufba.br

FRAUNHOFER IESE CONTACT PERSONS

Dial Phone No.
+49 631 6800- ...

Executive Board

1001 Prof. Dieter Rombach
Executive Director
dieter.rombach@iese.fraunhofer.de



1101 Prof. Peter Liggesmeyer
Scientific Director
peter.liggesmeyer@iese.fraunhofer.de



1201 Prof. Frank Bomarius
Director of Operations
frank.bomarius@iese.fraunhofer.de



1205 Holger Westing
Managing Director
Department Head Central Services
holger.westing@iese.fraunhofer.de



Staff Functions

6000 Yvonne Ortiz Guadalupe
Head of PR / Marketing
and Assistant to the Executive Director
yvonne.ortiz@iese.fraunhofer.de



2239 Sonnhild Namingha
International Staff Advisor
Student Exchange Program
sonnhild.namingha@iese.fraunhofer.de



Division Managers

Department Heads

2272 Dr. Mario Trapp
Division
Embedded Systems
mario.trapp@iese.fraunhofer.de



2246 Dr. Martin Becker
Embedded Systems Development
(ESD)
martin.becker@iese.fraunhofer.de



2218 Sören Kemmann
Embedded Systems Quality
Assurance (ESQ)
soeren.kemmann@iese.fraunhofer.de



2193 Dr. Jens Heidrich
Division
Process Management
jens.heidrich@iese.fraunhofer.de



2193 Dr. Jens Heidrich
Measurement, Prediction &
Empiricism (MPE)
jens.heidrich@iese.fraunhofer.de



2103 Rolf Hendrik van Lengen
Process Compliance & Improvement
(PCI)
rolf.van.lengen@iese.fraunhofer.de



1601 Dr. Jörg Dörr
Division
Information Systems
joerg.doerr@iese.fraunhofer.de



2186 Dr. Marcus Trapp
Information Systems Development
(ISD)
marcus.trapp@iese.fraunhofer.de



2181 Michael Eisenbarth
Information Systems Quality
Assurance (ISQ)
michael.eisenbarth@iese.fraunhofer.de



Dial Phone No.
+49 631 6800- ...

Business Area Managers

1603 Ralf Kalmar
Produkt Industries
- Automotive and Transportation Systems
- Automation and Plant Engineering
- Medical Devices
ralf.kalmar@iese.fraunhofer.de



1604 Michael Ochs
IT and Service Industries
- Information Systems
Finance, ERP/Software, Telecommunication
- eGovernment
- Health Care
michael.ochs@iese.fraunhofer.de



International Coordinators

2272 Dr. Mario Trapp
USA
mario.trapp@iese.fraunhofer.de



2185 Dr. Christian Webel
Australia
christian.webel@iese.fraunhofer.de



2173 Dr. Karina Villela
Brazil
karina.villela@iese.fraunhofer.de



INFORMATION SERVICE

Fraunhofer-Institut für
Experimentelles Software Engineering
Fraunhofer-Platz 1

67663 Kaiserslautern
Germany

To receive further information, please fax us
a copy of this page.

Fax +49 631 6800-9 1002

Further Information

- Annual Report 2011/2012 of Fraunhofer IESE, print version (German)
- Annual Report 2011/2012 of Fraunhofer IESE, print version (English)
- Annual Report 2011/2012 of Fraunhofer IESE, CD-ROM version (German & English)
- Short films of Fraunhofer IESE, DVD, German
- Short films of Fraunhofer IESE, DVD, English
- Fraunhofer IESE: Overview
- The Fraunhofer-Gesellschaft from A-Z
- Annual Report of Fraunhofer-Gesellschaft
- STI Software Technologie Initiative Kaiserslautern e. V.
- Please add my address

A PDF file of the Fraunhofer IESE Annual Report 2011/2012 with included Appendix and other publications (press releases, previous Annual Reports) are available at

www.iese.fraunhofer.de

Fraunhofer IESE Point of Contact:

Yvonne Ortiz Guadalupe
Head of PR / Marketing
Telefon +49 631 6800-6000
Fax +49 631 6800-9 1002
presse@iese.fraunhofer.de



Return Address

Title

Last Name, First Name

Company

Position

Department

Address

Zip Code / City

Phone

Fax

E-mail



APPENDIX

Network in Science and Industry	138
Industrial Partners	138
National Research Partners	140
International Research Partners	140
International Software Engineering Network (ISERN)	141
Visitors Hosted	142
Professional Contributions	143
Lecturing Assignments	143
Editorial Boards	144
Committee Activities	145
Scientific and Technological Advisory Boards	148
Participation in Delegations	148
Memberships in Industrial Advisory Boards	149
Memberships in Professional Associations	149
Keynotes	149
Presentations	150
Scientific Contributions	154
Books	154
Articles in Books	154
Articles in Journals	154
Contributions to Conference Proceedings	156
Proceedings by Editors	160
Fraunhofer IESE Reports	161
Other Technical Reports	163
Doctoral Theses	163
Master's Theses	163
Bachelor's Theses	163
Awards	164
Internal Awards	164
External Awards	164
Appointments	164

NETWORK IN SCIENCE AND INDUSTRY

INDUSTRIAL PARTNERS¹

- ::: tsm total-sourcing-management, Nuremberg
- 1&1 Internet AG, Karlsruhe
- Ab.Acus srl, Milan, Italy
- ABB AG, Mannheim
- Absint Angewandte Informatik GmbH, Saarbrücken
- Accellere GmbH, St. Augustin
- Accenture CAS GmbH, Kaiserslautern
- actano GmbH, Munich
- Adam Opel GmbH, Rüsselsheim
- Airbus Deutschland, Hamburg
- Albrecht JUNG GmbH & Co. KG, Schalksmühle
- ALENIA SIA SPA, Turin, Italy
- ALSTOM Transport S.A., Levallois Perret, France
- andrena objects ag, Karlsruhe
- Ansaldo Sts, Genova, Italy
- Astrium, Paris, France
- Atlas Elektronik GmbH, Bremen
- Audi AG, Ingolstadt
- Audi Electronics Venture GmbH, Gaimersheim
- AVL LIST GmbH, Graz, Austria
- Axpo Holding, Basel, Switzerland
- B2M Software AG, Karlsruhe
- BASF SE, Ludwigshafen
- B. BRAUN AVITUM AG, Melsungen
- BearingPoint GmbH, Berlin
- Berlin Heart GmbH, Berlin
- Binder Elektronik GmbH, Sinsheim
- BMW Group Forschung und Technik GmbH, Munich
- Bosch Rexroth Electric Drives and Controls GmbH, Lohr a. Main
- BrandMaker GmbH, Karlsruhe
- BTC Embedded Systems AG, Oldenburg
- Capgemini sd&m AG, Munich
- CAS Software AG, Karlsruhe
- CIBEK technology + trading GmbH, Limburgerhof
- Cisco Systems GmbH, Stuttgart
- Comlet Verteilte Systeme GmbH, Zweibrücken
- CONNCEPT SWISS GMBH, Basel, Switzerland
- Continental Automotive GmbH, Hannover
- Continental Teves AG & Co. oHG, Frankfurt
- ConWeaver GmbH, Darmstadt
- Corisecio GmbH, Darmstadt
- CosmosDirekt, Saarbrücken
- Daimler AG, Ulm
- Dassault Systèmes, Suresnes, France
- DENSO AUTOMOTIVE Deutschland GmbH, Eching
- Deutsche Bahn AG, Berlin
- Deutsche Lufthansa AG, Frankfurt
- Deutsche Telekom AG, Neuss
- Diehl Aerospace GmbH, Überlingen
- EADS Deutschland GmbH, Munich
- Eaton Electric BV, Hengelo, The Netherlands
- Eckert & Ziegler BEBIG GmbH, Berlin
- Elektrobit Automotive GmbH, Erlangen
- Elma Trenew Electronic GmbH, Pforzheim
- ESG Consulting GmbH, Fürstenfeldbruck
- ETAS Entwicklungs- und Applikationswerkzeuge für elektronische Systeme GmbH, Stuttgart
- EUROSEC GmbH, Kronberg
- Eyed GmbH, Saarbrücken
- FibuNet GmbH, Kaltkirchen
- FIMI S.R.L., Milano, Italy
- Ford Forschungszentrum Aachen GmbH, Aachen
- ForTISS GmbH, Garching
- Fredhopper, Amsterdam, The Netherlands
- FTI Engineering Network GmbH, Blankenfelde-Mahlow
- Fujitsu Laboratories of Europe Ltd., Hayes, UK
- Globus SB-Warenhaus Holding GmbH & Co. KG, St. Wendel
- HegerFerrit GmbH, Enkenbach-Alsenborn
- Hella KGaA Hueck & Co, Lippstadt
- Hocoma AG, Volketswil, Switzerland
- ICT Solutions AG, Trier
- IDCH Germany GmbH, Lemberg
- IDS Scheer, Saarbrücken
- IHK Darmstadt Service GmbH, Darmstadt
- IHK Zetis GmbH, Kaiserslautern
- IMACS GmbH, Bad Kreuznach/Planig
- IMC AG, Saarbrücken
- Infinion Technologies, Neubiberg
- Insiders GmbH, Kaiserslautern
- Intel GmbH, Feldkirchen
- intelligent views gmbh, Darmstadt
- IT Power Consultants, Berlin
- itestra GmbH, Kaufering
- John Deere European Technology Innovation Center, Kaiserslautern
- John Deere Moline Technology Innovation Center, Moline, USA

1) Industrial Partners are located in Germany unless stated otherwise.

- KEIPER GmbH & Co. KG, Kaiserslautern
- KOBIL Systems GmbH, Worms
- Krauss-Maffei Wegmann GmbH & Co. KG, Kassel
- KSB Aktiengesellschaft, Pegnitz
- Liebherr-Aerospace, Lindenberg
- Lufthansa Systems Passenger Services GmbH, Raunheim
- Medcom Gesellschaft für medizinische Bildverarbeitung mbH, Darmstadt
- MELAG oHG Medizintechnik, Berlin
- mineway GmbH, Saarbrücken
- Mitsubishi Research Institute Inc. (MRI), Tokyo, Japan
- MIZAR Automazione S.P.A., Turin, Italy
- Motorola GmbH, Traunstein
- MULTITEL ASBL, Mons, Belgium
- Murex S.A.S., Paris, France
- N.A.T. GmbH, St. Augustin
- Netbiscuits GmbH, Kaiserslautern
- Ontoprise GmbH, Karlsruhe
- OpenSynergy GmbH, Berlin
- OrgaTech Unternehmensberatung, Lünen
- Philips Consumer Lifestyle Advanced Technology, Eindhoven, The Netherlands
- Porsche Engineering Group GmbH, Weissach
- Porsche Informatik GmbH, Bergheim, Austria
- proALPHA Software AG, Weilerbach
- psb intralogistics GmbH, Pirmasens
- P+S WERFTEN GmbH, Stralsund
- QA Systems GmbH Stuttgart
- RA Dres. Müller & Altmeyer, Saarbrücken
- RadiSys GmbH, Hallbergmoos
- R&D-Ware Oy, Espoo, Finland
- Robert-Bosch GmbH, Stuttgart
- Roche Diagnostics GmbH, Mannheim
- Roland Berger Strategy Consultants GmbH, Hamburg
- RST Industrie Automation GmbH, Ottobrunn
- SAP AG, Walldorf
- Schalker Eisenhütte Maschinenfabrik GmbH, Gelsenkirchen
- Schenker AG, Essen
- SEEBURGER AG, Bretten
- SIEDA GmbH, Kaiserslautern
- Siemens AG, Munich
- Sirrix AG, Saarbrücken
- Software AG, Darmstadt
- Sopera GmbH, Bonn
- Sportbund Rheinhessen, Mainz
- SWM Services GmbH, Munich
- Sysgo AG, Klein-Winternheim
- TecNet GmbH, Berlin
- Terex Demag GmbH, Zweibrücken
- Testo AG, Lenzkirch
- T-Systems Enterprise Services GmbH, Frankfurt
- TÜV SÜD Automotive GmbH, Munich
- Ubigrate GmbH, Dresden
- User Interface Design GmbH, Ludwigsburg
- UT GESTION TIC ECOPE-ROL, Bogotá, Colombia
- Vector Informatik GmbH, Stuttgart
- Vision Tools Bildanalyse Systeme GmbH, Waghäusel
- Vodafone Omnitel N.V., Ivrea, Italy
- Volkswagen Aktiengesellschaft, Wolfsburg
- Volvo Technology Corporation, Göteborg, Sweden
- Wind River GmbH, Ismaning
- Wiwie GmbH, Bexbach
- XING AG, Hamburg
- XiSys Software GmbH, Randersacker

NATIONAL RESEARCH PARTNERS

- Arbeitsgruppe Softwaretechnik, Universität Bremen (Software Engineering Research Group, University of Bremen), Bremen
- CyberForum e.V., Karlsruhe
- DESY Deutsches Elektronen-Synchrotron, Hamburg
- Deutsches Forschungszentrum für Künstliche Intelligenz GmbH (DFKI) (German Research Center for Artificial Intelligence GmbH), Kaiserslautern/Saarbrücken
- Deutsche Informatik-Akademie (DIA), Bonn
- Deutsches Zentrum für Luft- und Raumfahrt e.V. (German Aerospace Center), Köln
- Fachbereich Maschinenbau, Fachhochschule Kaiserslautern (Department of Mechanical Engineering, Kaiserslautern University of Applied Sciences), Kaiserslautern
- Forschungszentrum Informatik (FZI) (Research Center for Information Technologies), Karlsruhe
- Georg-August-Universität Göttingen, Göttingen
- Hessisches Landesamt für Straßen- und Verkehrsweisen (Hessian State Office for Roads and Traffic), Frankfurt

- Hochschule für Technik und Wirtschaft des Saarlandes (Saarland University of Applied Science), Saarbrücken
- Humboldt-Universität zu Berlin, Berlin
- INI-GraphicsNet Stiftung, Darmstadt
- Institut für Informatik IV, Technische Universität München (Institute for Computer Science, TU München), Munich
- Institut für Medizinische Biometrie und Informatik, Universitätsklinikum Heidelberg (Institute for Medical Biometry and Informatics, Heidelberg University Hospital), Heidelberg
- Institut für Technische und Betriebliche Informationssysteme, Otto-von-Guericke-Universität Magdeburg (Department of Technical & Business Information Systems, Otto von Guericke University), Magdeburg
- Institut für Programmstrukturen und Datenorganisation, KIT Karlsruher Institut für Technologie (Karlsruhe Institute of Technology), Karlsruhe
- Lehrstuhl für Software Systeme, Universität Duisburg-Essen (Institute for Computer Science and Information Systems, University of Duisburg-Essen), Essen
- Oldenburger Forschungs- und Entwicklungsinstitut für Informatik-Werkzeuge und -Systeme OFFIS e.V. (Oldenburg Research and

Development Institute for Computer Science Tools and Systems), Oldenburg

- Regierungspräsidium Gießen (Gießen Regional Administrative Authority), Gießen
- Stadt Kaiserslautern (City of Kaiserslautern)
- Technische Universität Berlin
- Technische Universität Carolo-Wilhelmina, Braunschweig
- Technische Universität Darmstadt, Darmstadt
- Technische Universität Dresden, Dresden
- Technische Universität Kaiserslautern (University of Kaiserslautern), Kaiserslautern
- Technologie-Initiative SmartFactory KL e.V., Kaiserslautern
- Universität Paderborn, Paderborn
- Universität Würzburg, Würzburg
- VDI/VDE Innovation + Technik GmbH (VDI - The Association of German Engineers), Berlin
- Westpfalz-Klinikum GmbH, Kaiserslautern
- Zentralinstitut für Seelische Gesundheit (ZI) (Central Institute of Mental Health), Mannheim
- Zentrum für Wirtschaftsinformatik (Center for Business Informatics), Universität Mannheim, Mannheim

INTERNATIONAL RESEARCH PARTNERS

- Aalborg Universitet, Aalborg, Denmark
- AGE - The European Older People's Platform, Brussels, Belgium
- Aristotle University of Thessaloniki, Thessaloniki, Greece
- Bay Zoltan Foundation for Applied Research, Budapest, Hungary
- Budapest University of Technology and Economics, Biomedical Engineering Knowledge, Budapest, Hungary
- C-Base, Center for Empirically Based Software Engineering, Maryland, USA
- Center for Research and Technology Hellas, Thessaloniki, Greece
- Centre National de la Recherche Scientifique, Paris, France
- Centro Ricerche Fiat, Torino, Italy
- Chalmers Tekniska Högskola Aktiebolag, Göteborg, Sweden
- Clemson University, Clemson, USA
- Congregazione Suore Infermiere dell' Addolorata "Ospedale Valduce", Como, Italy
- Eidgenössische Technische Hochschule (Swiss Federal Institute of Technology), Zurich, Switzerland
- European Software Institute, Zamudio, Spain
- Experimental Software Engineering Group (UMD/ESEG), University of Maryland, College Park, USA

- Graz University of Technology, Graz, Austria
 - Groupe des Ecoles de Télécom, Institut National de Télécommunications, Évry Cedex, France
 - Hungarian Association for Home Care and Hospice, MOH, Budapest, Hungary
 - Informationssicherheit / ZISC, Eidgenössische Technische Hochschule Zürich (Zurich Information Security Center, Swiss Federal Institute of Technology Zurich), Zurich, Switzerland
 - Information-technology Promotion Agency, Tokyo, Japan
 - Institut National de Recherche en Informatique et Automation, Le Chesnay, France
 - Instituto de Ciencias Matemáticas de Computação, Universidade de São Paulo, São Paulo, Brazil
 - ITACA, Valencia, Spain
 - Japan Aerospace Exploration Agency JAXA, Tokyo, Japan
 - Katholieke Universiteit Leuven, Leuven, Belgium
 - Kungliga Tekniska Högskolan, Stockholm, Sweden
 - Kyungpook National University, Daegu, South Korea
 - Laboratory for Software Engineering Decision Support, University of Calgary, Calgary, Canada
 - Lulea Tekniska Universitet, Lulea, Sweden
 - National ICT Australia (NICTA), Eveleigh, Australia
 - National Technical University of Athens, Athens, Greece
 - Norwegian University of Science & Technology, Trondheim, Norway
 - Office National d'Etudes et de Recherche Aéropatiales, Chatillon, France
 - Politecnico di Milano, Milan, Italy
 - Poznan University of Technology, Poznan, Poland
 - SIMULA Research Laboratory, Lysaker, Norway
 - Stichting Centrum voor Wiskunde en Informatica, Amsterdam, The Netherlands
 - Stiftelsen SINTEF, Trondheim, Norway
 - The University of Newcastle upon Tyne, Newcastle upon Tyne, UK
 - TNO, The Hague, The Netherlands
 - Tongmyong University, Busan, South Korea
 - Tsinghua University, Beijing, China
 - Universidad Politécnica de Madrid, Madrid, Spain
 - Universidade Estadual da Paraíba, Campina Grande, Brazil
 - Universidade Federal da Bahia, Salvador, Brazil
 - Università degli Studi di Trieste, Trieste, Italy
 - Università di Bologna, Bologna, Italy
 - Universitetet i Oslo, Oslo, Norway
 - University of Manchester, Manchester, UK
 - Vienna University of Technology, Vienna, Austria
 - VTT Electronics, Oulu, Finland
- INTERNATIONAL SOFTWARE ENGINEERING NETWORK (ISERN)**
- Aalto University School of Science and Technology (TKK), Finland
 - ABB Corporate Research, USA
 - Avaya Labs, USA
 - Blekinge Institute of Technology, Sweden
 - Brigham Young University, USA
 - COPPE/Rio de Janeiro Federal University, Brazil
 - Fraunhofer Center for Experimental Software Engineering Maryland, USA
 - Fraunhofer Institute for Experimental Software Engineering, Germany
 - Free University of Bolzano-Bozen, Italy
 - Information-technology Promotion Agency, Japan
 - Institute of Software, Chinese Academy of Sciences (ISCAS) - Lab for Internet Software Technology, China
 - IT University Copenhagen, Denmark
 - Japan Manned Space Systems Corporation JAMMS, Japan
 - Japan Aerospace Exploration Agency JAXA, Japan
 - Kalemun Research Inc., Canada
 - Leiden University, The Netherlands
 - Lund University, Sweden
 - Massachusetts Institute of Technology, USA
 - Microsoft Research, USA
 - Nara Institute of Science and Technology, Japan
 - Naval Postgraduate School, USA
 - North Carolina State University, USA
 - Northrop Grumman, USA
 - Norwegian University of Science and Technology, Norway
 - NTT Data Corporation, Japan
 - Osaka University, Japan
 - Queens University, Belfast, UK
 - R&D Ware Oy, Finland
 - Robert BOSCH GmbH, Germany
 - Simula, Norway
 - SINTEF, Norway
 - Technische Universität München, Germany
 - Universidad Politécnica de Madrid, Spain
 - Universidad Politécnica de Valencia, Spain
 - Università degli Studi dell'Insubria, Italy
 - Università degli Studi di Roma Tor Vergata, Italy
 - University of Alabama, USA
 - University of Alberta, Canada
 - University of Auckland, New Zealand
 - University of Bari, Italy
 - University of Calgary, Canada
 - University of Castilla-La Mancha, Spain
 - University of Hawaii, USA

- University of Helsinki, Finland
- University of Kaiserslautern, Germany
- University of Maryland-Baltimore County, USA
- University of Maryland-College Park, USA
- University of New South Wales, Australia
- University of Oslo, Norway
- University of Oulu, Finland
- University of Sheffield, UK
- University of Southern California, USA
- University of Stuttgart, Germany
- University of Technology Sydney, Australia
- University Politecnico di Torino, Italy
- University of Uruguay (ORT), Uruguay
- USC's Information Sciences Institute, USA
- Vienna University of Technology, Austria
- VTT Electronics, Finland

VISITORS HOSTED

Mr. Yusaku Nakata - Executive Director, Information-technology Promotion Agency; Mr. Joji Tateishi - Senior Vice President, Software Engineering Center, Information-technology Promotion Agency; Mr. Katsutoshi Shinatni - Chief Advisor, Software Engineering Center, Information-technology Promotion Agency; Mr. Yasuhiro Kikushima - Deputy Chief Information Officer at National Personnel Authority; Research Fellow at Software Engineering Center, Information-technology Promotion Agency; Mr. Norifumi Nomura - General Manager at Consulting Department, Solutions Business Promotion Division, ITOCHU Techno-Solutions Corporation; Mr. Hisayoshi Adachi - Senior Manager, Corporate SEPG, Denso Corporation, Tokyo, Japan, January 26, 2011

Prof. Dr. Elisa Yumi Nakagawa, Professor, Dept. of Computer Systems, USP - University of São Paulo, Sao Carlos, Brazil, February 1, 2011 - January 31, 2012

Matthew Crissler, Clemson University, Clemson, SC, USA May - July 31, 2011

Dr. Ihor Khuz, NICTA, Sydney, Australia, May 2 - July 1, 2011

Dr. Olawande Daramola, Post-Doctoral Researcher, NTNU, Trondheim, Norway, June 26 -July 2, 2011

Manny Weber, Bachelor student, ETH, Zurich, Switzerland, June 27 - July 10, 2011

Dr. Kosaku Kimura, Software Innovation Laboratory, Fujitsu, Kawasaki, Japan, September 5 - 16, 2011

Daniel Cardoso de Morais, Bachelor student, Dept. of Electrical Engineering, Universidad Federal de Campina Grande, Campina Grande, Brazil, September 17, 2011 - February 28, 2012

Felipe de Farias Viana, Bachelor student, Dept. of Mechanical Engineering, Universidad Federal da Paraiba, João Pessoa, Brazil, September 17, 2011 - February 28, 2012

Liher Granado Lopez de Letona, Master student, MGEP (Mondragon Goi Eskola Politekniko), Mondragon, Spain, October 1, 2011 - June 30, 2012

Dr. Victor Pankratius, Head of Multicore Software Engineering investigator group, Karlsruhe Institute of Technology, Karlsruhe, Germany, October 12, 2011

PROFESSIONAL CONTRIBUTIONS

LECTURING ASSIGNMENTS

Becker, M.:

Lecture
Product Line Engineering,
Computer Science Department,
University of Kaiserslautern
Winter 2010/2011
Winter 2011/2012

Bomarius, F.:

Lecture
PDA, Mechatronics, University
of Applied Sciences Kaiserslautern
Winter 2011/2012

Lecture
RA, Mechatronics, University
of Applied Sciences Kaiserslautern
Winter 2011/2012

Lecture
OOSE, Mechatronics, University
of Applied Sciences Kaiserslautern
Winter 2011/2012

Lecture
SEES, Mechatronics, University
of Applied Sciences Kaiserslautern
Winter 2011/2012

Dörr, J.:

Lecture
Requirements Engineering,
Computer Science Department,
University of Kaiserslautern
Winter 2010/2011
Winter 2011/2012

Lecture
Software Entwicklung 2,
Computer Science Department,
University of Kaiserslautern
Summer 2011

Heidrich, J.:

Lecture
Process Modeling, Computer
Science Department, University
of Kaiserslautern
Summer 2011

Lecture
Software Project and Process
Management; Computer Science
Department, University
of Kaiserslautern
Summer 2011

Goepfert, B.:

Lecture
Organization of Internal
Information Centers, Faculty
III Media, Information and
Design, University of Applied
Sciences and Arts of Hannover
Winter 2011/2012

Hussain, T.:

Lecture
Steuerungstechnik (Logic
Control), Electrical and Com-
puter Engineering Department,
University of Kaiserslautern
Winter 2010/2011

Kuhn, T.:

Lecture
Operating Systems, Com-
puter Science Department,
University of Kaiserslautern
Summer 2011

Knodel, J.:

Lecture
Software Maintenance and
Evolution, Computer Science
Department, University of
Applied Sciences Mannheim
Summer 2011

Lecture
Framework-based GUI Devel-
opment, Computer Sciences
/ Microsystems Technology
Department, University of Ap-
plied Sciences Kaiserslautern
Winter 2011/2012

Lecture
Software Architecture, Com-
puter Science Department,
University of Applied Sciences
Mannheim
Summer 2012

Liggesmeyer, P.:

Lecture
Sicherheit und Zuverlässigkeit
eingebetteter Systeme,
Computer Science Depart-
ment, University of Kaisers-
lautern
Winter 2010/2011
Winter 2011/2012

Lecture
Qualitätsmanagement von
Software und Systemen,
Computer Science Depart-
ment, University of Kaisers-
lautern
Winter 2011/2012

Lecture
Software-Qualitätssicherung,
Computer Science Depart-
ment, University of Kaisers-
lautern
Winter 2010/2011

Maier, A.:

Single Lecture
Software Ergonomie und Us-
ability - Barrierefreiheit,
Computer Science Depart-
ment, University of Applied
Sciences Mannheim
Jan 18, 2011

Putz, W.:

Lecture
XML-Sprachfamilie, Com-
puter Science Department,
Hochschule Darmstadt
Winter 2010/2011
Winter 2011/2012

Rombach, D.:

Lecture
Grundlagen des Software En-
gineering (in English), Com-
puter Science Department,
University of Kaiserslautern
Winter 2010/2011
Winter 2011/2012

Bachelor Project
Grundlagen des Software
Engineering (in English), with
Prof. Liggesmeyer & Prof.
Poetzsch-Heffter, Computer
Science Department, Univer-
sity of Kaiserslautern
Summer 2011

Lecture
Software Project and Process
Management; Computer Sci-
ence Department, University
of Kaiserslautern
Summer 2011

Lecture
Empirical Model Building and
Methods, Computer Science
Department, University of
Kaiserslautern
Summer 2011

Lecture
Requirements Engineering,
Computer Science Depart-
ment, University of Kaisers-
lautern
Winter 2010/2011
Winter 2011/2012

Lecture
Product Line Engineering,
Computer Science Department,
University of Kaiserslautern
Winter 2010/2011
Winter 2011/2012

Lecture
Process Modeling, Computer
Science Department, University of
Kaiserslautern
Summer 2011

Master Project
Software Engineering: Software
Evolution, Computer
Science Department, University of
Kaiserslautern
Winter 2010/2010
Winter 2011/2012

Master Project
Software Engineering: Team-
based Software Development,
Computer Science Department,
University of Kaiserslautern
Winter 2010/2011
Winter 2011/2012

Rudolph, M.:
Single Lecture
Public Key Infrastructure,
Computer Science Department,
University of Applied Sciences
Mannheim
Dec 7, 2011

Simon, K.:
Lecture
Entwicklung angriffssicherer
Software, Computer Sciences
/ Microsystems Technology
Department, University of
Applied Sciences Kaiserslautern/
Zweibrücken
Summer 2011

Weitzel, B.:
Lecture
Frameworkbasierte GUI-Entwick-
lung, Computer Sciences
/ Microsystems Technology
Department, University of
Applied Sciences Kaiserslautern/
Zweibrücken
Winter 2011/2012

Wessner, M.:
Lecture
Ambient Intelligent Systems,
Media Department, University
of Applied Sciences Darmstadt
Winter 2010/2011
Winter 2011/2012

Lecture
Quality Management
Media Department, University
of Applied Sciences Darmstadt
Summer 2011

EDITORIAL BOARDS

Bomarius, F.:
Member, Editorial Board,
Ph.D. Theses in Experimental
Software Engineering,
Fraunhofer IRB Publishing
Company, since 2001

Dörr, J.:
Journal Reviewer, Business &
Information Systems Engineering,
since 2010

Journal Reviewer, The Computer
Journal, since 2011

Journal Reviewer, Requirements
Engineering Journal,
since 2011

Liggesmeyer, P.:
Editor, it – information technology,
Oldenbourg-Verlag,
München, since 2003

Member, Editorial Board,
Lecture Notes in Informatics
(LNI), Gesellschaft für Informatik
GI, Springer, since 2003

Editor, Informatik – Forschung
und Entwicklung,
Springer, since 2000

Member, Editorial Board,
Ph.D. Theses in Experimental
Software Engineering,
Fraunhofer IRB Publishing
Company, since 2004

Luiz, T.:
Coordinating Editor, Medizinische
Gefahrenabwehr,
since 2009

Münch J.:
Co-Guest Editor, Software
Process Improvement and
Practice Journal, John Wiley
and Sons, since 2006

Member, Editorial Board,
e-Informatica, since 2006

Rombach, D.:
Associate Editor, IEEE Transactions
on Software Engineering,
since 2003

Associate Editor, International
Journal of Empirical Software
Engineering, Springer-Verlag,
since 1996

Member, Editorial Board,
International Journal of Software
Process: Improvement and
Practice, John Wiley and Sons,
since 1994

Member, Editorial Board,
Informatik: Forschung und
Entwicklung,
Gesellschaft für Informatik GI,
Springer, since 1993

Member, Editorial Board,
Ph.D. Theses in Experimental
Software Engineering,
Fraunhofer IRB Publishing
Company, since 2000

Member, Editorial Board,
International Journal of
Software and Informatics,
Institute of Software, Chinese
Academy of Sciences, Beijing,
since 2007

Wessner, M.:

Member, Editorial Board, Journal of Educational Multimedia and Hypermedia, Association for the Advancement of Computing in Education, Chesapeake, USA, since 2005

Member, Editorial Board, International Journal of Computer-Supported Collaborative Learning since 2008

Member, Editorial Review Board, Journal of Interactive Learning Research, since 2009

COMMITTEE ACTIVITIES**Becker, M.:**

Member, Program Committee, SPLC Doctoral Symposium, 15th International Software Product Line Conference (SPLC 2011), Munich, Germany, August 21-26, 2011

Member, Program Committee, 2nd International Workshop on Formal Methods in Software Product Line Engineering FMSPLE 2011, 15th International Software Product Line Conference (SPLC 2011), Munich, Germany, August 21-26, 2011

Carbon, R.:

Member, Program Committee, Workshop on Integrating Mobile Devices into the Car Ecosystem - Tablets and Smartphones as Vital Part of the Car, 3rd International Conference on Automotive User Interfaces and Interactive Vehicular Applications (AutomotiveUI'11), Salzburg, Austria, November 30 - December 2, 2011

Dörr, J.:

Member, Advisory Committee, 2nd International Workshop on Replication in Empirical Software Engineering Research (RESER), Empirical Software Engineering International Week (ESEIW 2011), Banff, Canada, September 21, 2011

Chair, Empirical Studies Track, 17th Intl. Conference on Requirements Engineering: Foundation for Software Quality (REFSQ), Essen, Germany, March 28, 2011

Organizer, GI Fachgruppentreffen Requirements Engineering, Hamburg, Germany, November 24 - 25, 2011

Member, Program Committee, 17th Intl. Conference on Requirements Engineering: Foundation for Software Quality (REFSQ 2011), Essen Germany, March 28 - 30, 2011

Member, Program Committee, Workshop on Empirical Research in Requirements Engineering: Challenges and Solutions (EPICAL), 17th Intl. Conference on Requirements Engineering: Foundation for Software Quality (REFSQ 2011), Essen, Germany, March 31, 2011

Member, Program Committee, Industry Track, 19th IEEE International Requirements Engineering Conference (RE 2011), Trento, Italy, August 19 - September 2, 2011

Member, Program Committee, International Workshop on Empirical Requirements Engineering (Empire), 19th IEEE International Requirements Engineering Conference (RE 2011), Trento, Italy, August 30, 2011

Eisenbarth, M.:

Member, Program Committee, Workshop on Integrating Mobile Devices into the Car Ecosystem - Tablets and Smartphones as Vital Part of the Car, 3rd International Conference on Automotive User Interfaces and Interactive Vehicular Applications (AutomotiveUI'11), Salzburg, Austria, November 30 - December 2, 2011

Elberzhager, F.:

Member, Program Committee, 37th EUROMICRO Conference on Software Engineering and Advanced Applications (SEAA 2011), Oulu, Finland, August 30 - September 2, 2011

Gross, A.:

Member, Program Committee, Workshop on Integrating Mobile Devices into the Car Ecosystem - Tablets and Smartphones as Vital Part of the Car, 3rd International Conference on Automotive User Interfaces and Interactive Vehicular Applications (AutomotiveUI'11), Salzburg, Austria, November 30 - December 2, 2011

Hess, S.:

Chair/Organizer, Workshop on Integrating Mobile Devices into the Car Ecosystem - Tablets and Smartphones as Vital Part of the Car, 3rd International Conference on Automotive User Interfaces and Interactive Vehicular Applications (AutomotiveUI'11), Salzburg, Austria, November 30 - December 2, 2011

Jedlitschka, A.:

Session Chair, 5th International Symposium on Empirical Software Engineering and Measurement (ESEM 2011), Banff, Canada, September 19-23, 2011

Organizer, 9th International Advanced School of Empirical Software Engineering (IASESE 2011), Banff, Canada, September 21, 2011

Session Chair, 19th Annual Meeting of the International Software Engineering Research Network (ISERN 2011), Banff, Canada, September 19-20, 2011

Member, Steering Committee, 12th International Conference on Product Focused Software Development and Process Improvement (PROFES 2011), Torre Canne, Italy, June 20-22, 2011

Member, Program Committee, 6th International Symposium on Empirical Software Engineering and Measurement (ESEM 2012), Lund, Sweden, September, 20-21, 2012

Program Co-Chair, 13th International Conference on Product Focused Software Development and Process Improvement (PROFES 2012) Madrid, Spain, June 13-15, 2012

Kläs, M.:

Session Chair, Kontinuierliche Software-Entwicklung, DASMA Metrik Kongress (METRIKON 2011), Kaiserslautern, Germany, November 17-18, 2011

Knodel, J.:

Doctoral Symposium Chair, 15th European Conference on Software Maintenance and Reengineering (CSMR 2011), Oldenburg, Germany, March 1-4, 2011

Workshop Co-Chair, 18th Working Conference on Reverse Engineering (WCRE 2011), Limerick, Ireland, October 17-20, 2011

Tutorial Chair, 16th European Conference on Software Maintenance and Reengineering (CSMR 2012), Szeged, Hungary, March 27-30, 2012

Member, Program Committee, 16th European Conference on Software Maintenance and Reengineering (CSMR 2012), Szeged, Hungary, March 27-30, 2012

Member, Program Committee, Tool Demo Track, 16th European Conference on Software Maintenance and Reengineering (CSMR 2011), Szeged, Hungary, March 27-30, 2012

Kuhn, T.

Member, Program Committee, SDL Forum 2011, Toulouse, France, July 5-7, 2011

Liggismeyer, P.

Member, Program Committee, Software Engineering 2011 (SE 2011), Karlsruhe, Germany, February 21-26, 2011

Member, Program Committee, Third Workshop on Leveraging Empirical Research for Software Business Success (EPIC 2011), 2nd International Conference on Software Business (ICSOB 2011), Brussels, Belgium, June 8-10, 2011

Member, Program Committee, 3rd International Workshop on Model-Based Verification and Validation (MVV 2011), Fifth International Conference on Secure Software Integration and Reliability Improvement (SSIRI 2011), Jeju Island, Korea, June 27-29, 2011

Member, Program Committee, 6th International Conference on Software Process and Product Measurement (Mensura 2011), Nara, Japan, November 3-4, 2011

Member, Program Committee, CVT Symposium 2012, Kaiserslautern, Germany, March 13-15, 2012

Member, Program Committee, The IEEE Signature Conference on Computer Software & Applications (COMPSAC 2012), Izmir, Turkey, July 16-20, 2012

Member, Program Committee, 31st International Conference on Computer Safety, Reliability and Security (SAFECOMP 2012), Magdeburg, Germany, September 25, 2012

Maier, A.:

Member, Program Committee, Workshop on Integrating Mobile Devices into the Car Ecosystem - Tablets and Smartphones as Vital Part of the Car, 3rd International Conference on Automotive User Interfaces and Interactive Vehicular Applications (AutomotiveUI'11), Salzburg, Austria, November 30 - December 2, 2011

Münch, J.

Co-Organizer, 4. Workshop zur Software-Qualitätsmodellierung und -bewertung (SQMB '11), Software Engineering 2011 (SE 2011), Karlsruhe, Germany, February 21-26, 2011

Member, Program Committee, International Conference on Software and Systems Process (ICSSP 2011), Honolulu, Hawaii, USA, May 21-22, 2011

Member, Program Committee, 12th International Conference on Product Focused Software Development and Process Improvement (PROFES 2011), Torre Canne, Italy, June 20-22, 2011

Member, Program Committee, Software Process and Product Improvement (SPPI), 37th EUROMICRO Conference on Software Engineering and Advanced Applications (SEAA 2011), Oulu, Finland, August 30 - September 2, 2011

Member, Program Committee, DASMA Metrik Kongress (METRIKON 2011), Kaiserslautern, Germany, November 17-18, 2011

Co-Organizer, DASMA Metrik Kongress (METRIKON 2011), Kaiserslautern, Germany, November 17-18, 2011

Rombach, D.:

Coordinator, German-Hungarian Cooperation, TU Kaiserslautern, since 2004

Chair, Steering Committee, ISERN Workshop Series

Chair, IEEE Committee on Harlan Mills Award (since 2009)

Chair, IEEE/SEI Committee on Software Process Achievement Award (since 2009)

Coordinator, International Software Engineering Network (ISERN), since 1996

Schwarz, R.:

Member, Program Committee, The 5th International Conference on Information Security and Assurance (ISA 2011), Brno, Czech Republic, August 15-17, 2011

Member, Program Committee, The 2nd International Conference on Security-enriched Urban Computing and Smart Grids (SUComS 2011), Hualien, Taiwan, September 21-23, 2011

Member, Program Committee, 2011 International Conference on Security Technology (SecTech 2011), Jeju Island, Korea, December 8-10, 2011

Trapp, Marcus:

Organizer, Workshop on Integrating Mobile Devices into the Car Ecosystem - Tablets and Smartphones as Vital Part of the Car, 3rd International Conference on Automotive User Interfaces and Interactive Vehicular Applications (AutomotiveUI'11), Salzburg, Austria, November 30 - December 2, 2011

Villela, K.:

Member, Program Committee, Workshop Produktlinien im Kontext: Technologie, Prozesse, Business und Organisation (PIK 2011), Software Engineering 2011 (SE 2011), Karlsruhe, Germany, February 22, 2011

Member, Program Committee, 10th Brazilian Symposium on Software Quality (SBQS 2011), Curitiba, Brazil, June 6-10, 2011

Co-Organizer, 15th International Software Product Line Conference (SPLC 2011), Munich, Germany, August 21-26, 2011

Co-Organizer, 1st Workshop on Services, Clouds, and Alternative Design Strategies for Variant-Rich Software Systems (SCARVES 2011), 15th International Software Product Line Conference (SPLC 2011), Munich, Germany, August 22, 2011

Co-Organizer, 2nd International Workshop on Formal Methods and Analysis in Software Product Line Engineering, (FMSPLE 2011), 15th International Software Product Line Conference (SPLC 2011), Munich, Germany, August 26, 2011

Member, Program Committee, 25th Brazilian Symposium on Software Engineering (SBES 2011), São Paulo Brazil, September 26-30, 2011

Wessner, M.:

Member, Program Committee, 9th International Conference on Computer-Supported Collaborative Learning (CSCL2011), Hong Kong, China, July 4-8, 2011

Member, Program Committee, e-Learning Fachtagung Informatik (DeLFI 2011), Dresden, Germany, September 5-8, 2011

Member, Program Committee, World Conference on E-Learning in Corporate, Government, Healthcare & Higher Education (E-Learn 2011), Honolulu/Hawaii, USA, October 17-21, 2011

Member, Program Committee, 4th International Conference on Computer Supported Education (CSEDU 2012), Porto, Portugal, April 16-18, 2012

Member, Program Committee, IADIS International Conference e-Learning 2012, Lisbon, Portugal, July 17-20, 2012

Member, Program Committee, e-Learning Fachtagung Informatik (DeLFI 2012), Hagen, Germany, September 24-26, 2012

Member, Program Committee, World Conference on E-Learning in Corporate, Government, Healthcare & Higher Education (E-Learn 2012), Montréal, Canada October 9-12, 2012

SCIENTIFIC AND TECHNOLOGICAL ADVISORY BOARDS

Dörr, J.:

Spokesperson (& Member), Gesellschaft für Informatik e.V. (GI), Fachgruppe Requirements Engineering, Germany, since 2010

Member, Steering Committee, International Conference on Requirements Engineering: Foundation for Software Quality (REFSQ), since 2011

Eschbach, R.:

Member, VDI-Fachausschuss "Qualitätssicherung für Software in der Medizintechnik", since 2008

Member, VDI/VDE GMA Fachausschuss 1.50 Methoden der Steuerungstechnik, since 2008

Göpfert, B.:

Member, STAR-Anwenderbeirat, Munich, Germany, since October 2007

John, I.:

Member, Steering Committee, SPLC Software Product Line Conference, since 2010

Kerkow, D.:

Member, VDI-Fachausschuss "Qualitätssicherung für Software in der Medizintechnik", Dusseldorf, Germany, since 2008

Member, Forum MedTech Pharma e.V.; Geschäftsstelle Bayern innovativ GmbH, Nuremberg, Germany, since 2008

Guest member, Normierungsgremium DKE, (VDE, DIN) UK 811.4, Frankfurt, Germany, since 2008

Klaus, A.:

Member, VDI-Fachausschuss "Qualitätssicherung für Software in der Medizintechnik", since 2009

Liggemeyer, P.:

Vice-President, Gesellschaft für Informatik e.V. (GI), Bonn, Germany, since 2012

Member, Steering Committee, Gesellschaft für Informatik e.V. (GI), Germany, since 1999

Chair, Special Interest Group "Softwaretechnik", Gesellschaft für Informatik e.V. (GI), Germany, since 1999

Spokesperson (& Member), Fraunhofer-Allianz Embedded Systems, Germany, since 2010

Münch, J.:

Member, Committee, Diploma Thesis Awards, DASMA e.V., Germany, since 2005

Rombach, D.:

Coordinator, ISERN (International Software Engineering Research Networks), since 1996

Member, Advisory Board, Fraunhofer Center Maryland, College Park, USA, since 1998

Member, Advisory Board, Otto A. Wipprecht-Stiftung, Germany, since 1999

Member, Advisory & Expert Group for the Minister President of Rhineland-Palatinate, Germany, since 2002

Chair, Board, SEI Process Achievement Award, USA, since 2009

Chair, Committee, IEEE Harlan D. Mills Award, USA, since 2009

Member, Steering Committee, KIST (Korea Institute of Science and Technology) Europe Forschungsgesellschaft mbH, Korea, since 2006

Member, Scientific Advisory Board, NICTA (National Information and Communications Technologies Australia), Australia, since 2006

Member, Advisory Board, Business and Innovation Center (BIC), Kaiserslautern, Germany, since 2007

Member, Advisory Board, An-Institut fortis, Munich, Germany, since 2009

Schwarz, R.:

Founding Member, Committee, International Secure Software Engineering Council (ISSECO), Potsdam, Germany, since 2008

Wessner, M.:

Member, Steering Board, Special Interest Group "E-Learning", Gesellschaft für Informatik (GI), since 2002

PARTICIPATION IN DELEGATIONS

Rombach, D.:

Member, City of Kaiserslautern Business Delegation, Lord Mayor Dr. Klaus Weichel, Thiruvananthapuram/Kerala/Kochi, India, January 16-19, 2011

Liggemeyer, P.:

Member, Civic Leader Tour Washington DC, several Air Force Bases, USA, May 9-13, 2011

MEMBERSHIPS IN INDUSTRIAL ADVISORY BOARDS

Münch, J.:

Member, Advisory Board, SASQIA / OrgaTech GmbH, Lünen, Germany, since 2006

Member, Advisory Board, ACCEL GmbH, Lünen, Germany, since 2006

Rombach, D.:

Member, Advisory Board, Stiftung der Gasanstalt, Kaiserslautern, Germany, since 2002

Member, Advisory Board, Stadtparkasse Kaiserslautern, Kaiserslautern, Germany, since 2004

Chairman of the Board., 1. FC Kaiserslautern (Professional Soccer Club), Kaiserslautern, Germany, since 2008

MEMBERSHIPS IN PROFESSIONAL ASSOCIATIONS

AAL-Allianz

Access SOS Emergency

ACL – Association for Computational Linguistics

ACM – Association of Computing Machinery

AGBC – American-German Business Club Deutschland e.V.

AMS – American Mathematical Society

ASQF e.V. – Arbeitskreis Software-Qualität in Franken

BV-Päd. – Bundesverband der Diplom-Pädagoginnen und Diplom-Pädagogen e.V.

CAST e.V. – Competence Center for Applied Security Technology

CVC – Commercial Vehicle Cluster

DASMA – German Software Metrics and Effort Estimation Association

DGI – Deutsche Gesellschaft für Informationswissenschaft und Informationspraxis e.V.

DIN – Deutsches Institut für Normung

Förderverein Informatik TU KL/FIT

Fraunhofer Academy

Freundeskreis TU KL

gc-UPA – German Chapter of the Usability Professionals' Association

GDM – Gesellschaft für Didaktik der Mathematik

GFal – Gesellschaft zur Förderung angewandter Informatik e.V.

GFFT – Gemeinnützige Gesellschaft zur Förderung des Forschungstransfers e.V.

GI – Gesellschaft für Informatik

idw – Informationsdienst Wissenschaft

IEEE – Institute of Electrical and Electronic Engineers

IMA – Institute of Mathematics and its Application

ISQI (Weit e.V.)

ISSECO – International Secure Software Engineering Council

IuK – Fraunhofer Information and Communication Group

LAP – Liberty Alliance Project

MedTech Pharma

OMG – Object Management Group

Open BC – Open Business Club

SafeTRANS – Safety in Transportation Systems

Science Alliance Kaiserslautern

Softwareforen Leipzig GmbH

STI – Software Technologie Initiative e.V.

Tekom – Fachverband für technische Kommunikation und Dokumentation

VDR – Verband Deutsches Reisemanagement e.V.

XING AG

KEYNOTES

Liggesmeyer, P.:

“Current Trends in Embedded Software Engineering”, Workshop on Model Integrated Mechatronics, Saarland University, Saarbrücken, Germany, January 27, 2011

“Anspruch & Machbarkeit bei der Entwicklung hochkritischer Softwaresysteme – Und was man daraus für den „Normalfall“ lernen kann”, IQ Roadshow: “Wenn Sie sich Fehler nicht leisten können!”, Logica GmbH, Munich, Germany, February 22, 2011

“Green by IT” oder “Green by ES”?, Green IT Forum 2011, Green IT, Berlin, Germany, February 23, 2011

“Software: Basis für Erzeugnisse, Produkte und Lösungen im 21. Jahrhundert”, Workshop „Embedded Systems und Systems Engineering”, ThyssenKrupp, Essen, Germany, March 15, 2011

“Softwareprüfung in Theorie und Praxis - Standards, Methoden, Techniken und deren Umsetzung”, QualityConf 2011 - Test with the Best, Deutsche Informatik Akademie, Munich, Germany, March 30, 2011

“Testen heute und in der Zukunft”, Konferenz Softwarequalitäts- und Testmanagement, Volkswagen AG, Wolfsburg, Germany, April 4, 2011

“Sicherheitsanalysen und Zertifizierung Eingebetteter Systeme”, Embedded Konferenz 2011, Wind River GmbH Stuttgart, Germany, May 24, 2011

“Current Trends in Embedded Software Engineering”, International Conference on Frontiers of Computer Science (ICFoCS-2011), Atria Institute of Technology in association with International Institute of Information Technology - IIIT Bangalore, Bangalore, India, August 8, 2011

“Intelligenter und sicherer durch den Alltag: Die große Stärke der kleinen Rechner”, SUCCESS - Vorsprung durch Innovation, Investitions- und Strukturbank Rheinland-Pfalz, (ISB) GmbH, Mainz, Germany, August 15, 2011

Rombach, D.:

“Software Engineering for Embedded Systems”, Colloquium at IIITM-K (Indian Institute of Information Technology & Management Kerala, Trivandrum, Kerala, India, January 17, 2011

“Digital veredelt – Innovated in Gemany: Der Maschinenbau des 21. Jahrhunderts entsteht im Software-Cluster”, Opening Panel, CeBIT, Hanover, Germany, March 1, 2011

“Innovationen durch verlässliche Software”, Net Economy, 3. Trendkongress, Keynote, Karlsruhe, Germany, April 8, 2011

“Towards a Science of Software Engineering: Empirical Models Capturing Cognitive SE Laws”, Invited Presentation, Microsoft Research Software Summit, Paris, France, April 14, 2011

“Empirical Software Engineering Models: Can they become the Equivalent of Physical Laws in Traditional Engineering?”, Keynote Presentation, Symposium in Honor of Barry Boehm, ISCAS, Beijing, China, April 27, 2011

“Towards a Science of Software Engineering: Empirical Models capturing Cognitive SE Laws”, Brazilian Software Engineering Conference SBES 2011, São Paulo, Brazil, September 28, 2011

“Theory and Practice”, Panel, Brazilian Software Engineering Conference SBES 2011, São Paulo, Brazil, September 28, 2011

“Wissenschaft als Impuls für nachhaltige Wirtschaftsentwicklung am Standort Kaiserslautern” (in German); Lecture Series, Rhineland-Palatinate Bank, Kaiserslautern, Germany, October 20, 2011

“Wissenschaft als Impuls für Lernen fürs Leben - Wie lassen sich Schulleistungen in MINT-Fächern effektiv fördern?”, 20. Landeseltern- tag, IGS Enkenbach-Alsenborn, Germany, November 5, 2011

PRESENTATIONS

Adam, S.:

“Service Oriented Architectures? Service Oriented Requirements Engineering!”, Presentation, REConf 2011, Munich, Germany, March 14, 2011

“Wenn Förster Software bauen – Anforderungsmanagement für das Bayerische Wald-Informationssystem”, Presentation, REConf 2011 Munich, Germany, March 16, 2011

“Is It Beneficial to Match Reusable Services Earlier?”, Conference Paper Presentation, 17th International Conference on Requirements Engineering: Foundation for Software Quality (REFSQ 2011), Essen, Germany, March 30, 2011

“Relevant Requirements in Product Line Application Engineering - A Foundation to Focus Elicitation”, Workshop Presentation, REEW 2011, Paluno Institute, Essen, Germany, March 31, 2011

“Requirements Engineering für das Bayerische Waldinformationssystem”, Presentation, Beamtentag “Neue Verwaltung”, Messe Leipzig, Leipzig, Germany, May 10, 2011

“Adressing Requirements Engineering Challenges in the Context of Emergent Systems”, Workshop Presentation, RES '4, Trento, Italy, August 30, 2011

“BPMN vs. EPK vs. User Cases”, Presentation, BPMN Anwendertag 2011, Hasso-Plattner-Institute HPI, Potsdam, Germany, September 29, 2011

“Produktlinien-bewusste Anforderungserhebung durch maßgeschneiderte Erhebungsprozesse”, Presentation, GI Fachgruppentreffen RE 2011, Blohm & Voss, Hamburg, Germany, November 25, 2011

Armbrust, O.:

“The Right Process For Each Context: Objective Evidence Needed”, Conference Paper Presentation, International Conference on Software and Systems Process (ICSSP 2011), Honolulu, Hawaii, USA, May 22, 2011

“The Right Process For Each Context: Objective Evidence Needed”, Panel Discussion, International Conference on Software and Systems Process (ICSSP 2011), Honolulu, Hawaii, USA, May 22, 2011

Becker, M.:

“Verlässliche Vertikale Integration”, Invited presentation, Bitkom AK SOA/ES Workshop, Bitkom AK SOA/ES, Munich, Germany, April 14, 2011

“Systemeigenschaften dank Architektur fest im Griff”, Conference Presentation, Embedded Software Engineering Kongress, MicroConsult Microelectronics Consulting & Training GmbH, Sindelfingen, Germany, December 8, 2011

Carbon, R.

“Business goes Mobile - Herausforderungen und Lösungen für mobile Geschäftsanwendungen”, Presentation, Seminar, University of Applied Sciences Kaiserslautern/Zweibrücken, Zweibrücken, Germany, May 25, 2011

“Mobile Business Applications must be thoroughly engineered”, Workshop Presentation, Workshop on Mobile Software Engineering, Mobicase 2011, Santa Monica, USA, October 27, 2011

Dörr, J.:

“A different „Perspective“ on Natural Language Requirements”, Invited Conference Presentation, 17th International Conference on Requirements Engineering: Foundation for Software Quality (REFSQ 2011), Essen Germany, March 29, 2011

“Some Thoughts on Empiricism in Requirements Engineering”, Invited Talk (Panel Discussion), Workshop on Empirical Research in Requirements Engineering: Challenges and Solutions, REFSQ 2011, Essen, Germany, March 31, 2011

Duszynski, S.:

Workshop Presentation, 16th CREST Open Workshop on Provenance and Product Lines, UCL, Department of Computer Science, London, UK, November 28, 2011

Elberzhager, F.:

“Optimizing Cost and Quality by Integrating Inspection and Test Processes”, Conference Paper Presentation, International Conference on Software and Systems Process (ICSSP 2011), Honolulu, Hawaii, USA, May 22, 2011

“The Relevance of Assumptions and Context Factors for the Integration of Inspections and Testing”, Conference Paper Presentation, 37th EUROMICRO Conference on Software Engineering and Advanced Applications (SEAA 2011), Oulu, Finland, September 2, 2011

“Using Early Quality Assurance Metrics to Focus Testing Activities”, Conference Paper Presentation, DASMA Metrik Kongress (METRIKON 2011), Kaiserslautern, Germany, November 17, 2011

Göpfert, B.:

“Marktrecherche in der Praxis am Beispiel des Fraunhofer IESE”, Presentation at Seminar, Seminar Marktrecherche Fraunhofer Marketing Netzwerk, Berlin, Germany, January 17, 2011

Gross, A.:

“UX meetis RE – Hohe User Experience durch bedarfsgerechte Anforderungsspezifikation”, Tutorial, German UPA 2011, FB Mensch-Computer-Interaktion der GI and German UPA, Chemnitz, Germany, September 11-14, 2011

“Anforderungen an die Anforderungsspezifikation aus Sicht von Architekten und Usability Experten”, GI Fachgruppentreffen RE 2011, GI Fachgruppe Requirements Engineering; Blohm + Voss Naval, Hamburg, Germany, November 24-25, 2011

Hess, S.:

“Differentiating Between Successful and Less Successful Products by Using MAInEEAC – A Model for Interaction Characterization”, Conference Paper Presentation, HCI International 2011, Orlando USA, July 14, 2011

“We Need Non-Formal Methods Based on Formal Models in Interaction Design”, Workshop Presentation, European Conference on Cognitive Ergonomics (ECCE 2011), Rostock, Germany, August 23, 2011

“Measuring the Impact of iPad Usage Concerning Perceived Work Efficiency in Business Environments”, Workshop Presentation, 13th International Conference on Human-Computer Interaction with Mobile Devices and Services (MobileHCI 2011), Stockholm, Schweden, August 30, 2011

“Integrating Mobile Devices into the Car User Experience”, Workshop Presentation, 13th IFIP TC13 Conference on Human-Computer Interaction (Interact 2011), Lisbon, Portugal, September 9, 2011

“Aus die Maus – Design für natürliche Interaktion”, Tutorial, German UPA Usability Professionals 2011, Chemnitz, Germany, September 11, 2011

“Mobile und Cloud – eine vielversprechende Kombination?”, Presentation, STI Jahrestagung, Kaiserslautern, Germany, October 26, 2011

Jung, J.:

“A Preliminary Survey on Subjective Measurements and Personal Insights into Factors of Perceived Future Project Success”, Short Paper Presentation, 5th International Symposium on Empirical Software Engineering and Measurement (ESEM 2011), Banff, Canada, September 23, 2011

Keuler, T.:

“SysML-basierte Anforderungsmodellierung: Model-checking als Black-box”, Conference Presentation, Embedded Software Engineering Kongress, Elektronik Praxis & Micro Consult, Sindelfingen, Germany, December 7, 2011

Klås, Mi.:

“HyDEEP - Integration von Expertenwissen und Fehlerdaten zur Einschätzung von Restfehlerrisiken”, Invited Talk, BITKOM, Frankfurt, Germany, July 7, 2011

“Adapting Software Quality Models: Practical Challenges, Approach, and First Empirical Results”, Conference Paper

Presentation, 37th EUROMI-CRO Conference on Software Engineering and Advanced Applications (SEAA 2011), Oulu, Finland, August 31, 2011

“Handling Estimation Uncertainty with Bootstrapping: Empirical Evaluation in the Context of Hybrid Prediction Methods”, Conference Paper Presentation, 5th International Symposium on Empirical Software Engineering and Measurement (ESEM 2011), Banff, Canada, September 23, 2011

“Defect Flow Modeling – Fehlermanagement und Verbesserung in der Praxis”, Tutorial, DASMA Metrik Kongress (METRIKON 2011), Kaiserslautern, Germany, November 17, 2011

“Qualitätsbewertung mit dem Quamoco Modell”, Invited Talk, Expertenforum Software Qualität, Munich, Germany, December 8, 2011

Klaus, A.:

“Neue Besen kehren gut: angepasste Software-Inspektionen zur Verbesserung Ihrer Sicherheit”, Presentation, ignite 2011, SQS Software Quality Systems AG, Düsseldorf, Germany, May 26, 2011

“Stakeholder-orientierter Software Test für Geschäftsanwendungen”, Presentation, GI TAV, Gesellschaft für Informatik e.V. (GI), Ausrichter: Fraunhofer FIRSE, Berlin, Germany, November 18, 2011

Knodel, J.:

“Architecture Compliance Checking: Überprüfung architektureller Vorgaben in der Implementierung”, Invited Talk, Software Foren Leipzig, User Group Architektur, Leipzig, Germany, February 23, 2011

“Rapid Architecture Evaluation (RATE)”, Invited Tutorial, 15th European Conference on Software Maintenance and Reengineering (CSMR 2011), Oldenburg, Germany, March 1, 2011

“Dokumentieren für die Entwicklung und nicht für die Schublade: Pragmatische Nutzung von Software Architekturen”, Invited Talk, Software Foren Leipzig, User Group Architektur, Leipzig, Germany, May 30, 2011

“Raus aus dem Elfenbeinturm. Die Rolle der Architektur im Software Engineering”, Invited Talk, Software Foren Leipzig, User Group Architektur, Leipzig, Germany, November 24, 2011

Kowalczyk, M.:

“Requirements for Process Management Support: Experience from the Japanese Aerospace Industry”, Conference Paper Presentation, International Conference on Software and Systems Process (ICSSP 2011), Honolulu, Hawaii, USA, May 21, 2011

“A Deployment Process for Strategic Measurement Systems”, Conference Paper Presentation, Software Measurement European Forum 2011 (SMEF 2011), Rome, Italy, June 11, 2011

“Aligning Software Processes with Organizational Purpose”, Conference Paper Presentation, DASMA Metrik Kongress (METRIKON 2011), Kaiserslautern, Germany, November 17, 2011

Kuhn, T.:

“Domain Specific Languages”, Invited Presentation, BICC.NET annual workshop, BICC.NET, Munich, Germany, April 8, 2011

“Trends in Software Architecture”, Invited Presentation, Bombardier Workshop, Bombardier, Luzern, Switzerland, September 20, 2011

“LP Optimization approach”, Invited Presentation, Airbus Research Workshop, Airbus, Hamburg, Germany, December 14, 2011

Lampasona, C.:

“Supporting the Adaptation of Software Quality Models – An Empirical Investigation” Workshop Presentation, 4. Workshop zur Software-Qualitätsmodellierung und -bewertung (SQMB '11), Software Engineering 2011 (SE 2011), Karlsruhe, Germany, February 21, 2011

Luiz, T.:

“How to optimize hospital admission in acute stroke”, Workshop Presentation, Internationalization of the Health Industry – Dubai Health, Dubai Health Authority, Dubai, United Arab Emirates, January 25, 2011

“Emergency medicine: a logistic challenge”, Invited Lecture, 5th Rhine-Main Future Congress, Zentrum für Forschungskoordination und Bildung, Offenbach, Germany, February 24, 2011

“The rescue chain in the era of information technology”, Invited Lecture, 5th Rhine-Main Future Congress, Zentrum für Forschungskoordination und Bildung, Offenbach, Germany, February 24, 2011

“Safety at mass events: Preparedness and realisation ifrom the view of an emergency physician”, Invited Lecture, Symposium “How to manage mass disasters and mass events”, University Hospital of Frankfurt, Frankfurt, Germany, April 7, 2011

“Emergency medicine: History, status quo and future” Invited Lecture, 40th anniversary, Dept. of Anesthesiology, Diakonie Hospital Mannheim Speyer, Speyer, Germany, May 13, 2011

“Triage in mass casualties”, Workshop Presentation, Workshop National Disaster Preparedness, Bundesamt für Bevölkerungsschutz und Katastrophenhilfe, Bad-Neuenahr-Ahrweiler, Germany, May 30, 2011

“How to Minimize Delays in Prehospital Treatment of Acute Stroke”, Workshop Presentation, Internationalization of the Health Industry – State of Rhineland-Palatinate, Rhineland-Palatinate Ministry of Economic Affairs, Climate Protection, Energy and State Regional Planning, Mainz, Germany, June 8, 2011

Invited Presentation, Sitzung des Krankenhausplanungsausschusses Rheinland-Pfalz, Ministerium für Soziales, Arbeit, Gesundheit und Demographie, Mainz, Germany, November 29, 2011

Poster Presentation, 11. Kongress der Deutschen Interdisziplinären Vereinigung für Intensiv- und Notfallmedizin DIVI, Deutsche Interdisziplinäre Vereinigung für Intensiv- und Notfallmedizin, Leipzig, Germany, December 1, 2011

Naab, M.:

“Enhancing Architecture Design Methods for Improved Flexibility in Long-Living Information Systems”, Conference Paper Presentation, 5th European Conference on Software Architecture (ECSA 2011), Essen, Germany, September 15, 2011

Riegel N.:

“Prioritizing business process chains for IT optimization”, Workshop Presentation, Requirements Prioritization for customer oriented Software Development (RePriCo 2011), 17th International Conference on Requirements Engineering: Foundation for Software Quality (REFSQ 2011), Essen, Germany, March 31, 2011

Rombach, D.:

“Der Mittelstand als innovativer Motor der Wirtschaft”, 28. Unternehmerstammtisch, Eisenberg, Germany, March 23, 2011

“Zukunft der Technik – Technik der Zukunft”, Jahrestagung Landesarbeitsgemeinschaft SchuleWirtschaft, Kaiserslautern, Germany, March 31, 2011

“Worksite Automation Competence @ Kaiserslautern”, Dinner Talk, John Deere Worksite Automation Conference, Kaiserslautern, Germany, April 7, 2011

“Anforderungen an Studenten aus dem Blickwinkel der Informatik (Hochschule, Forschung & Praxis)”, 102. MNU-Kongress, Mainz, Germany, April 8, 2011

“Lernen fürs Leben - Wie lassen sich Schulleistungen in MINT-Fächern effektiv fördern?”, 20. Landeseltern-tag, IGS Enkenbach-Alsenborn, Germany, November 5, 2011

Rudolph, M.:

“Security Evaluation of Service-oriented Systems with an Extensible Knowledge Base”, Workshop Presentation, Fifth International Workshop on Secure Software Engineering (SecSE 2011), The Sixth International Conference on Availability, Reliability and Security (ARES2011), Vienna, Austria, August 23, 2011

Schäfer, C.:

“A Pattern-based Approach to DSL Development” Workshop Presentation, DSM Workshop, Domain-Specific Modeling (DSM Forum), Portland, USA, 23.10.2011

“IMA modeling approach”, Invited Presentation, Airbus Research Workshop, Airbus, Hamburg, Germany, March 3, 2011

Schwarz, R.:

“Smart Metering Security: Das BSI-Schutzprofil für künftige Zähler-Gateways”, Workshop Presentation, Treffen des Kompetenznetzwerks Smart Grids, Kaiserslautern, Germany, September 9, 2011

Trapp, Marcus

“User Experience for Business Applications – UXelerate your Business”, Invited Talk, SAP Design Forum, SAP, St. Leonrot, Germany, May 27, 2011

“Geschäftserfolg durch positive User Experience”, Invited Talk, Agilität & User Experience, Accelsis, Fraunhofer IESE, Frankfurt, Germany June 16, 2011

“Usability heißt jetzt UX, sonst ändert sich nix ... Oh doch!”, Lightning Talk, German Testing Day, Frankfurt, Germany, November 9, 2011

“autoMOBILE”, Invited Talk, World Usability Day, Mannheim, Germany, November 10, 2011

Trendowicz, A.:

“Closing the Management Gap. Linking Software Development and Business Strategy through Measurement”, Invited Talk, 5. Arbeitstreffen der Users Group “Softwaretest und Qualitätssicherung” zum Thema: “Metriken im Kontext von Risikomanagement, Steuerungsmöglichkeiten, Testnutzen, Reporting”, Leipzig, Germany, April 4.-5, 2011

“Closing the Management Gap. Linking Software Development and Business Strategy Through Measurement”, Invited Talk, Seminar: Neue Software-Trends – Application Management – Agile Entwicklung & Testen, Conect Informunity, Vienna, Austria, September 15, 2011

Wickenkamp, A.:

“Dynamic Identification, Extraction and Reuse of Software Components in Distributed Development Scenarios” Conference Paper Presentation, DASMA Metrik Kongress (METRIKON 2011), Kaiserslautern, Germany, November 18, 2011

SCIENTIFIC CONTRIBUTIONS²

BOOKS

Busch, August; Claßen, Katrin; **Groß, Anne**; Gaden, Udo; Häring, Sabine; Heusinger, Stefan; Hildebrand, Claudia; Klein, Bernd; Klippert, Jürgen; Loss, Kay; Metzger, Nadine; Ott, Alexander; Schindler, Bernd; Scholtysek, Frank; Schöpe, Lothar; Seitz, Thomas; Sträter, Oliver; **Villela, Karina**: Qualitätskriterien im Umfeld von AAL. Produkte, Dienstleistungen, Systeme. Berlin: VDE-VERLAG, 2011 ISBN 978-3-8007-3397-2

ARTICLES IN BOOKS

Choras, Michal; D'Antonio, Salvatore; Iannello, Giulio; **Jedlitschka, Andreas**; Kozik, Rafal; Miesenberger, Klaus; Woloszczuk, Adam: Innovative Man Machine Interfaces and Solutions to Support Totally Blind People. In: Choras, Ryszard S. (Ed.): Image Processing and Communications Challenges 3: Advances in Intelligent and Soft Computing 2011 Berlin: Springer-Verlag, 2011, 437-444 (Advances in Intelligent and Soft Computing 102)

Lengen, Rolf van:

Deutsches Zentrum für Notfallmedizin und Informationstechnologie (DENIT) In: Lüttgen, Roderich (Hrsg.); Biese, Arno (Hrsg.): Handbuch des Rettungswesens: Erste Hilfe, Notfallrettung und Krankentransport Witten: Mendel, 2011, G, 3 p.

Nehmer, Jürgen; Becker, Martin; Kleinberger, Thomas; Prückner, Stephan: Elektronische Notfallüberwachung: Sensorbasierte Erfassung und Prävention von kritischen Gesundheitszuständen. In: Lindenberger, Ulman (Hrsg.); **Nehmer, Jürgen** (Hrsg.); Steinhagen-Thiessen, Elisabeth (Hrsg.); Delius, Julia A. M. (Hrsg.); Schellenbach, Michael (Hrsg.): Altern und Technik Stuttgart: Wissenschaftliche Verlagsgesellschaft mbH, 2011, 73-86 (Altern in Deutschland 6)

ARTICLES IN JOURNALS

Adam, Sebastian; Riegel, Norman; Doerr, Joerg; Uenalan, Oezguer; Kerkow, Daniel: From Business Processes to Software Services and Vice Versa - An Improved Transition through Service-oriented Requirements Engineering. In: Journal of Software Maintenance and Evolution Research and Practice (2011), Published Online: 29 SEP 2011, 22 p.

Ciupa, Ilinca; **Pretschner, Alexander**; Oriol, Manuel; Leitner, A.; Meyer, B.: On the Number and Nature of Faults found by Random Testing. In: Software Testing Verification & Reliability 21 (2011), 1, 3-28; First Published Online: 6 Jul 2009

Eschbach, Robert; Poore, Jesse H.: Guest Editorial: Special Section from 6th Workshop on Advances in Model-Based Testing (A-MOST 2010). In: Information and Software Technology 53 (2011), 11, 1250-1251

Eschbach, Robert: Simulink-Modelle automatisch testen. In: ELEKTRONIKPRAXIS. Embedded Software Engineering Report (2011), 3, 14-15

Gotzhein, Reinhard; **Kuhn, Thomas**: Black Burst Synchronization (BBS) - A protocol for deterministic tick and time synchronization in wireless networks. In: Computer Networks 55 (2011), 13, 3015-3031

Jeswein, Thomas; Riegel, Norman; Rombach, H. Dieter: Priorisierung von Prozessketten zwischen Wirtschaft und Verwaltung. In: eGovernment Review 4 (2011), 8, 12-13

John, Isabel: Identifikationen von Anforderungen aus Benutzerdokumentation. In: Softwaretechnik-Trends 31 (2011), 1, 18-19

Kuhn, Thomas; Barkowski, Donald; Kalmar, Ralf: Software-Parallelisierung für Multicore-Hardware. In: ATZ elektronik 6 (2011), 1, 66-70

Lamersdorf, Ansgar; **Münch, Jürgen**; Fernández-del Viso Torre, Alicia; Sánchez, Carlos Rebate; **Heinz, Markus; Rombach, H. Dieter**: A rule-based model for customized risk identification and evaluation of task assignment alternatives in distributed software development projects. In: Journal of Software Maintenance and Evolution Research and Practice (2011), Published Online: 23 NOV 2011, 15 p.

2) Names of CESE and Fraunhofer IESE members appear in bold.

- Luiz, Thomas; Lengen, Rolf van; Wickenkamp, Axel;** Kranz, T.; Madler, Christian: Verfügbarkeit bodengebundener Notarztstandorte in Rheinland-Pfalz: Landesweites webbasiertes Erfassungs-, Anzeige- und Auswerteinstrument.
In: Der Anaesthetist 60 (2011), 5, 421-426, First Published Online: 23 December 2010
- Luiz, Thomas;** Madler, Christian; Kreimeier, Uwe: Notfallversorgung - eine logistische Herausforderung.
In: Notfall und Rettungsmedizin 14 (2011), 3, 178-179
- Luiz, Thomas; Lengen, Rolf van:** Vereinheitlichung von Leitstellenstrukturen und -prozessen als Teil des Qualitätsmanagements im rheinland-pfälzischen Rettungsdienst: Teil I: Planung und technische Umsetzung.
In: Notfall und Rettungsmedizin 14 (2011), 3, 180-186
- Luiz, Thomas;** Döriges, Volker: Logistik in der Notfallmedizin.
In: Notfallmedizin up2date 6 (2011), 3, 201-216
- Mishra, Alok; **Münch, Jürgen;** Mishra, Deepti: Information Systems in Distributed Environments: ISDE 2010.
In: ACM SIGSOFT Software Engineering Notes 36 (2011), 3, 28-30
- Nehmer, Jürgen; Luiz, Thomas;** Sibomana, Consolée: The Intelligent Bed - Ambient Monitoring of Sick and Disabled Persons through the Use of Load Sensors in Bed Legs.
In: ERCIM NEWS (2011), 87, 26-27
- Prückner, Stephan; Martin, Sandra; **Kleinberger, Thomas;** Madler, Christian; **Luiz, Thomas:** Logistische Aspekte in der Notfallmedizin beim alten Menschen.
In: Notfall und Rettungsmedizin 14 (2011), 3, 197-201
- Rombach, H. Dieter:** Empirical Software Engineering Models: Can They Become the Equivalent of Physical Laws in Traditional Engineering?
In: International Journal of Software and Informatics 5 (2011), 3, 525-534
- Rombach, H. Dieter; Storf, Holger; Kleinberger, Thomas:** Situation-of-Helplessness Detection System for Senior Citizens.
In: ERCIM NEWS (2011), 87, 32-33
- Scherer, Guido; **Luiz, Thomas:** Eckpunktepapier zur notfallmedizinischen Versorgung der Bevölkerung in der Prä- und Hospitalphase. Wie ist es praktisch umsetzbar?
In: Der Anaesthetist 60 (2011), 8, 751-758
- Scherer, Guido; **Luiz, Thomas:** ZLB 2.0 in Rheinland-Pfalz: Quantensprung in der Versorgung von Notfallpatienten.
In: Rettungsdienst. Zeitschrift für präklinische Notfallmedizin 34 (2011), 10, 20-24
- Trapp, Mario; Kuhn, Thomas; Liggesmeyer, Peter:** Modellbasierte Entwicklung eingebetteter Softwaresysteme.
In: ELEKTRONIKPRAXIS. Embedded Software Engineering Report (2011), 1, 14-15
- Trapp, Sonja;** Ramollari, Ervin; **Heintz, Matthias;** **Weber, Sebastian;** Dranidis, Dimitris; Böstler, Jürgen: Collaborative Learning of UML and SysML.
In: International Journal of Engineering Pedagogy 1 (2011), 2, 6-12
- Zehler, Thomas;** Steffens, Petra: Qualitätssicherung in interdisziplinären eGovernment-Projekten: Adaption bewährter Praktiken im P23R-Projekt.
In: eGovernment Review 4 (2011), 8, 20-21

CONTRIBUTIONS TO CONFERENCE PROCEEDINGS

Adam, Sebastian; Uenal, Oezguer; Riegel, Norman: Is It Beneficial to Match Reusable Services Earlier? (International Working Conference on Requirements Engineering. Foundation for Software Quality <17, 2011, Essen>) In: Berry, Daniel (Ed.); Franch, Xavier (Ed.): Requirements Engineering: Foundation for Software Quality. 17th International Working Conference, REFSQ 2011 - Proceedings Berlin: Springer-Verlag, 2011, 136-150 (Lecture Notes in Computer Science 6606)

Adam, Sebastian: Towards Faster Application Engineering through Better Informed Elicitation - A Research Preview. (International Working Conference on Requirements Engineering. Foundation for Software Quality <17, 2011, Essen>) In: Berenbach, Brian (Ed.); Daneva, Maya (Ed.); Doerr, Joerg (Ed.); Fricker, Samuel (Ed.); Gervasi, Vincenzo (Ed.); Glinz, Martin (Ed.); Herrmann, Andrea (Ed.); Krams, Benedikt (Ed.); Madhavji, Nazim H. (Ed.); Paech, Barbara (Ed.); Schockert, Sixten (Ed.); Seyff, Norbert (Ed.); Universität Duisburg-Essen: 17th International Working Conference on Requirements Engineering: Foundation for Software Quality. Proceedings of the REFSQ 2011 Workshops REEW, EPICAL and RePriCo, the REFSQ 2011

Empirical Track (Empirical Live Experiment and Empirical Research Fair), and the REFSQ 2011 Doctoral Symposium. 2011, 32-37 (ICB Research Report 44)

Adler, Rasmus; Domis, Dominik J.; **Höfig, Kai; Kemmann, Sören; Kuhn, Thomas;** Schwinn, Jean-Pascal; **Trapp, Mario:** Integration of Component Fault Trees into the UML. (IEEE/ACM International Conference on Model Driven Engineering Languages and Systems <13, 2010, Oslo>) In: Dingel, Juergen (Ed.); Solberg, Arnor (Ed.): Models in Software Engineering. Workshops and Symposia at MODELS 2010 - Reports and Revised Selected Papers Berlin: Springer-Verlag, 2011, 312-327 (Lecture Notes in Computer Science 6627)

Antonino, Pablo; Schneider, Daniel; Hofmann, Cristian; Nakagawa, Elisa Yumi: Evaluation of AAL Platforms According to Architecture-based Quality Attributes. (International Joint Conference on Ambient Intelligence <2, 2011, Amsterdam>) In: Keyson, David V. (Ed.); Maher, Mary Lou (Ed.); Streitz, Norbert (Ed.); Cheok, Adrian (Ed.); Augusto, Juan Carlos (Ed.); Wichert, Reiner (Ed.); Englebienne, Gwenn (Ed.); Aghajan, Hamid (Ed.); Kröse, Ben J. A. (Ed.): Ambient Intelligence. Second International Joint Conference. Aml 2011 - Proceedings Berlin: Springer-Verlag, 2011, 264-274 (Lecture Notes in Computer Science 7040)

Armbrust, Ove; Rombach, H. Dieter: The Right Process For Each Context: Objective Evidence Needed. (International Conference on Software and Systems Process <2011, Waikiki>) In: Raffo, David (Ed.); Pfahl, Dietmar (Ed.); Zhang, Li (Ed.); Association for Computing Machinery (ACM): Proceedings of the 2011 International Conference on Software and Systems Process - ICSSP'11 New York: ACM Press, 2011, 237-241

Becker, Martin; Keuler, Thorsten; Knodel, Jens: Systemeigenschaften dank Architektur fest im Griff. (Embedded Software Engineering Kongress <2011, Sindelfingen>) Tagungsband. Embedded Software Engineering Kongress 2011, 2011, 15-21

Benavides, David; Leucker, Martin; **Becker, Martin;** Rabiser, Rick; **Villela, Karina;** Wong, Peter Y. H.: Formal Methods and Analysis in Software Product Line Engineering (FMSPL 2011). International Software Product Line Conference <15, 2011, München>) In: Almeida, Eduardo Santana (Ed.); Kishi, Tomoji (Ed.); Schwanninger, Christa (Ed.); **John, Isabel** (Ed.); Schmid, Klaus (Ed.): 15th International Software Product Line Conference, SPLC 2011 - Proceedings Los Alamitos : IEEE Computer Society, 2011, p. 336

Breiner, Kai; Meixner, Gerrit; **Rombach, H. Dieter;** Seissler, Marc; Zühlke, Detlef: Efficient Generation of Ambient Intelligent User Interfaces. (International Conference on Knowledge-Based and Intelligent Information and Engineering Systems <15, 2011, Kaiserslautern>) In: König, Andreas (Ed.); Dengel, Andreas (Ed.); Hinkelmann, Knut (Ed.); Kise, Koichi (Ed.); Howlett, Robert J. (Ed.); Jain, Lakhmi C. (Ed.): Knowledge-Based Intelligent Information and Engineering Systems. 15th International Conference. KES 2011 - Proceedings, Part IV Berlin : Springer-Verlag, 2011, 136-145 (Lecture Notes in Artificial Intelligence - Subseries of Lecture Notes in Computer Science 6884)

Duszynski, Slawomir: A Scalable Goal-Oriented Approach to Software Variability Recovery. (International Software Product Line Conference <15, 2011, München>) Proceedings of the 15th International Software Product Line Conference, SPLC 2011 - Second Volume New York: ACM Press, 2011, 8 p.

Duszynski, Slawomir; Knodel, Jens; Becker, Martin: Analyzing the Source Code of Multiple Software Variants for Reuse Potential. (Working Conference on Reverse Engineering <18, 2011, Limerick>)

In: Pinzger, Martin (Ed.); Poshyanyk, Denys (Ed.); Buckley, Jim (Ed.): 18th Working Conference on Reverse Engineering. WCRE'2011 - Proceedings Los Alamitos: IEEE Computer Society, 2011, 303-307

Eisenbarth, Michael; Hess, Steffen; Maier, Andreas; Trapp, Marcus:

Integrating Mobile Devices into the Car User Experience. (IFIP TC 13 International Conference on Human-Computer Interaction <13, 2011, Lisbon>) User Experience in Cars. Workshop at Interact 2011 - Workshop Proceedings 2011, 28-31

Elberzhager, Frank; Münch, Jürgen; Rombach, H. Dieter; Freimut, Bernd:

Optimizing Cost and Quality by Integrating Inspection and Test Processes. (International Conference on Software and Systems Process <2011, Waikiki>)

In: Raffo, David (Ed.); Pfahl, Dietmar (Ed.); Zhang, Li (Ed.): Association for Computing Machinery (ACM): Proceedings of the 2011 International Conference on Software and Systems Process - ICSSP'11 New York: ACM Press, 2011, 3-12

Elberzhager, Frank; Eschbach, Robert; Münch, Jürgen:

The Relevance of Assumptions and Context Factors for the Integration of Inspections and Testing. (EUROMICRO Conference <37, 2011, Oulu>)

In: Biffel, Stefan (Ed.); Koivuluoma, Mika (Ed.); Abrahamsson, Pekka (Ed.); Oivo, Markku (Ed.): EUROMICRO 2011. Proceedings of the 37th EUROMICRO Conference on Software Engineering and Advanced Applications Los Alamitos : IEEE Computer Society, 2011, 388-391

Groß, Anne; Hess, Steffen:

UX meets RE. Hohe User Experience durch bedarfsgerechte Anforderungsspezifikation. In: Brau, Henning (Ed.); Lehmann, Andreas (Ed.); Petrovic, Kostanija (Ed.); Schroeder, Matthias C. (Ed.): German Usability Professionals Association e.V.: Usability Professionals 2011 2011, 24-29

Heckemann, Karl; Gesell, Manuel; Pfister, Thomas; **Berns, Karsten; Schneider, Klaus; Trapp, Mario:** Safe Automotive Software. (International Conference on Knowledge-Based and Intelligent Information and Engineering Systems <15, 2011, Kaiserslautern>)

In: König, Andreas (Ed.); Dengel, Andreas (Ed.); Hinkelmann, Knut (Ed.); Kise, Koichi (Ed.); Howlett, Robert J. (Ed.); Jain, Lakhmi C. (Ed.): Knowledge-Based Intelligent Information and Engineering Systems. 15th International Conference. KES 2011 - Proceedings, Part IV Berlin : Springer-Verlag, 2011, 167-176 (Lecture Notes in Artificial Intelligence - Subseries of Lecture Notes in Computer Science 6884)

Hess, Steffen; Maier, Andreas; Trapp, Marcus: Differentiating between Successful and Less Successful Products by Using MAInEEAC - A Model for Interaction Characterization. (International Conference on Human-Computer Interaction <14, 2011, Orlando>)

In: Jacko, Julie A. (Ed.): Human-Computer Interaction. 14th International Conference, HCI International 2011 - Proceedings, Part I: Design and Development Approaches Berlin: Springer-Verlag, 2011, 238-247 (Lecture Notes in Computer Science 6761)

Hess, Steffen; Jung, Jessica: Measuring the Impact of iPad Usage Concerning Perceived Work Efficiency in Business Environments. (Workshop on Mobile Work Efficiency <2011, Stockholm>) Mobile Work Efficiency: Enhancing Workflows with Mobile Devices : Workshop at Mobile HCI 2011 2011, 4 S.

Hess, Steffen; Maier, Andreas; Trapp, Marcus: We Need Non-Formal Methods Based on Formal Models in Interaction Design. (European Conference on Cognitive Ergonomics <29, 2011, Rostock>)

In: Dittmar, Anke (Ed.); Forbrig, Peter (Ed.): Designing Collaborative Activities. European Conference on Cognitive Ergonomics - ECCE 2011: 29th annual conference of the European Association on Cognitive Ergonomics Rostock: Universitätsdruckerei Rostock, 2011, 287-288

Hess, Steffen; Meschtscherjakov, Alexander; Ronneberger, Torsten; **Trapp, Marcus:** Integrating Mobile Devices into the Car Ecosystem - Tablets and Smartphones as Vital Part of the Car. (International Conference on Automotive User Interfaces and Interactive Vehicular Applications <3, 2011, Salzburg>)

In: Tscheligi, Manfred (Ed.); Kranz, Matthias (Ed.); Weinberg, Garrett (Ed.); Meschtscherjakov, Alexander (Ed.); Murer, Martin (Ed.); David Wilfinger (Ed.): Universität Salzburg: Proceedings of the 3rd International Conference on Automotive User Interfaces and Interactive Vehicular Applications 2011, 210-211

John, Isabel; Silva, Adeline de Sousa:

Evaluating Variability Instantiation Strategies for Product Lines. (Workshop on Variability Modeling of Software-Intensive Systems <5, 2010, Namur>)

In: Association for Computing Machinery (ACM): Proceedings of the 5th Workshop on Variability Modeling of Software-Intensive Systems - VaMoS'11 New York: ACM Press, 2011, 105-113

Jung, Christian; Rudolph, Manuel; Schwarz, Reinhard: Security Evaluation of Service-oriented Systems with an Extensible Knowledge Base. (International Conference on Availability, Reliability and Security <6, 2011, Vienna>)

In: IEEE Computer Society: Sixth International Conference on Availability, Reliability and Security. ARES 2011 - Proceedings
Los Alamitos: IEEE Computer Society, 2011, 698-703

Jung, Jessica; Maier, Andreas; Groß, Anne; Ruiz, Natalie; Chen, Fang; Yin, Bo: Investigating the Effect of Cognitive Load on UX: A Driving Study. (International Conference on Automotive User Interfaces and Interactive Vehicular Applications <3, 2011, Salzburg>)

In: Universität Salzburg: Adjunct Proceedings of the 3rd International Conference on Automotive User Interfaces and Interactive Vehicular Applications 2011, 134-137

Kemmann, Sören; Kuhn, Thomas; Trapp, Mario: Extensible and Automated Model-Evaluations with IN-ProVE. (International Workshop on System Analysis and Modelling <6, 2010, Oslo>)
In: Kraemer, Frank Alexander (Ed.); Herrmann, Peter (Ed.): System Analysis and Modeling: About Models. 6th International Workshop, SAM 2010 - Revised Selected Papers
Berlin : Springer-Verlag, 2011, 193-208 (Lecture Notes in Computer Science 6598)

Keuler, Thorsten; Antonino, Pablo: SysML-basierte Anforderungsmodellierung - Model-checking als "Blackbox".

(Embedded Software Engineering Kongress <2011, Sindelfingen>) Tagungsband. Embedded Software Engineering Kongress 2011
2011, 30-33

Kläs, Michael; Lochmann, Klaus; Heinemann, Lars: Evaluating a Quality Model for Software Product Assessments - A Case Study. (Workshop zur Software-Qualitätsmodellierung und -bewertung <4, 2011, München>)

In: Wagner, Stefan (Hrsg.); Broy, Manfred (Hrsg.); Deibenböck, Florian (Hrsg.); **Liggsmeyer, Peter** (Hrsg.); **Münch, Jürgen** (Hrsg.); Technische Universität München. Institut für Informatik: Tagungsband 4. Workshop zur Software-Qualitätsmodellierung und -bewertung. SQMB' 11
München, 2011, 14-24

Kläs, Michael; Trendowicz, Adam; Ishigai, Yasushi; Nakao, Haruka: Handling Estimation Uncertainty with Bootstrapping: Empirical Evaluation in the Context of Hybrid Prediction Methods. (International Symposium on Empirical Software Engineering and Measurement <5, 2011, Banff>)
In: IEEE Computer Society: ESEM 2011. Proceedings of the Fifth 2011 International Symposium on Empirical Software Engineering and Measurement
Los Alamitos : IEEE Computer Society, 2011, 245-254

Kleinberger, Thomas; Jedlitschka, Andreas; Storf, Holger; Steinbach-Nordmann, Silke; Putz, Wolfgang; Groß, Anne:

Notfallerkennung und -prävention: Ergebnisse und Verwertung. (Deutscher AAL-Kongress mit Ausstellung <4, 2011, Berlin>)

In: Ambient Assisted Living Deutschland (AAL); VDE Verband der Elektrotechnik Elektronik Informationstechnik e. V.; Bundesministerium für Bildung und Forschung (BMBF): Demographischer Wandel - Assistenzsysteme aus der Forschung in den Markt. 4. Deutscher AAL-Kongress mit Ausstellung - Tagungsbeiträge
Berlin : VDE-VERLAG, 2011, 5 S.

Kloos, Johannes; Hussain, Tanvir; Eschbach, Robert: Risk-based Testing of Safety-Critical Embedded Systems Driven by Fault Tree Analysis. (IEEE International Conference on Software Testing, Verification, and Validation Workshops <4, 2011, Berlin>)

In: IEEE Computer Society: ICSTW 2011. Fourth IEEE International Conference on Software Testing, Verification, and Validation Workshops
Los Alamitos : IEEE Computer Society, 2011, 26-33

Kowalczyk, Martin; Armbrust, Ove; Katahira, Masafumi; Kaneko, Tatsuya; Miyamoto, Yuko; Koishi, Yumi: Requirements for Process Management Support: Experience from the Japa-

nese Aerospace Industry. (International Conference on Software and Systems Process <2011, Waikiki>)

In: Raffo, David (Ed.); Pfahl, Dietmar (Ed.); Zhang, Li (Ed.); Association for Computing Machinery (ACM): Proceedings of the 2011 International Conference on Software and Systems Process - ICSSP'11
New York : ACM Press, 2011, 179-183

Lampasona, Constanza; Kläs, Michael: Supporting the Adaptation of Software Quality Models - An Empirical Investigation. (Workshop zur Software-Qualitätsmodellierung und -bewertung <4, 2011, München>)

In: Wagner, Stefan (Hrsg.); Broy, Manfred (Hrsg.); Deibenböck, Florian (Hrsg.); **Liggsmeyer, Peter** (Hrsg.); **Münch, Jürgen** (Hrsg.); Technische Universität München. Institut für Informatik: Tagungsband 4. Workshop zur Software-Qualitätsmodellierung und -bewertung. SQMB' 11
München, 2011, 35-45

Moucha, Cornelius; Lovat, Enrico; Pretschner, Alexander:

A Hypervisor-Based Bus System for Usage Control. (International Conference on Availability, Reliability and Security <6, 2011, Vienna>)
In: IEEE Computer Society: Sixth International Conference on Availability, Reliability and Security. ARES 2011 - Proceedings
Los Alamitos : IEEE Computer Society, 2011, 254-259

Naab, Matthias:

Enhancing Architecture Design Methods for Improved Flexibility in Long-Living Information Systems. (European Conference on Software Architecture <5, 2011, Essen>) In: Crnkovic, Ivica (Ed.); Gruhn, Volker (Ed.); Book, Matthias (Ed.): Software Architecture. 5th European Conference, ECSA 2011 - Proceedings
Berlin : Springer-Verlag, 2011, 194-198 (Lecture Notes in Computer Science 6903)

Nakagawa, Elisa Yumi; Antonino, Pablo; Becker, Martin:

Exploring the Use of Reference Architectures in the Development of Product Line Artifacts. (International Software Product Line Conference <15, 2011, München>) Proceedings of the 15th International Software Product Line Conference, SPLC 2011 - Second Volume
New York : ACM Press, 2011, 8 S.

Nakagawa, Elisa Yumi; Antonino, Pablo; Becker, Martin:

Reference Architecture and Product Line Architecture: A Subtle But Critical Difference. (European Conference on Software Architecture <5, 2011, Essen>) In: Crnkovic, Ivica (Ed.); Gruhn, Volker (Ed.); Book, Matthias (Ed.): Software Architecture. 5th European Conference, ECSA 2011 - Proceedings
Berlin : Springer-Verlag, 2011, 207-211 (Lecture Notes in Computer Science 6903)

Nass, Claudia; Hess, Steffen:

Aus die Maus - Design für natürliche Interaktion. In: Brau, Henning (Hrsg.); Lehmann, Andreas (Hrsg.); Petrovic, Kostanija (Hrsg.); Schroeder, Matthias C. (Hrsg.); German Usability Professionals Association e.V.: Usability Professionals 2011
2011, 10-14

Nass, Claudia; Klöckner, Kerstin;

Klein, Rudolf; Schmitt, Hartmut; Diefenbach, Sarah: Entwicklung einer Geschäftsanwendung für multi-touch Interaktionsgeräte in einem KMU. (Jahrestagung der Gesellschaft für Informatik <41, 2011, Berlin>) In: Heiß, Hans-Ulrich (Hrsg.); Peppers, Peter (Hrsg.); Schlingloff, Holger (Hrsg.); Schneider, Jörg (Hrsg.); Gesellschaft für Informatik (GI): Informatik 2011. Informatik schafft Communities - Proceedings : Beiträge der 41. Jahrestagung der Gesellschaft für Informatik e.V. (GI)
Bonn: GI - Gesellschaft für Informatik, 2011, S. 341 (GI-Edition - Lecture Notes in Informatics (LNI) - Proceedings Volume P-192)

Neisse, Ricardo; Holling, Dominik; Pretschner, Alexander:

Implementing Trust in Cloud Infrastructures. (IEEE/ACM International Symposium on Cluster, Cloud and Grid Computing <11, 2011, Newport-Beach>) In: IEEE Computer Society; Association for Computing Machinery (ACM): 11th IEEE/ACM International Sympo-

sium on Cluster, Cloud and Grid Computing. CCGrid 2011 - Proceedings
Los Alamitos : IEEE Computer Society, 2011, 524-533

Neisse, Ricardo; Pretschner, Alexander;

Giacomo, Valentina Di: A Trustworthy Usage Control Enforcement Framework. (International Conference on Availability, Reliability and Security <6, 2011, Vienna>) In: IEEE Computer Society: Sixth International Conference on Availability, Reliability and Security. ARES 2011 - Proceedings
Los Alamitos : IEEE Computer Society, 2011, 230-235

Nunnenmacher, Sabine; Jung, Jessica;

Chehrizi, Golriz; Klaus, Alexander; Lampasona, Constanza; Webel, Christian; Ciolkowski, Marcus: A Preliminary Survey on Subjective Measurements and Personal Insights into Factors of Perceived Future Project Success. (International Symposium on Empirical Software Engineering and Measurement <5, 2011, Banff>) In: IEEE Computer Society: ESEM 2011. Proceedings of the Fifth 2011 International Symposium on Empirical Software Engineering and Measurement
Los Alamitos : IEEE Computer Society, 2011, 396-399

Riegel, Norman; Adam, Sebastian; Groß, Anne: Addressing requirements engineering challenges in the context of Emergent Systems. (Workshop on Requirements Engineering Engineering

for Systems, Services and Systems-of-Systems <2011, Trento>) 2011 Workshop on Requirements Engineering for Systems, Services and Systems-of-Systems
Los Alamitos : IEEE Computer Society, 2011, 6-9

Riegel, Norman; Uenalan, Oezguer; Jeswein, Thomas:

Prioritizing business process chains for IT optimization. (International Working Conference on Requirements Engineering. Foundation for Software Quality <17, 2011, Essen>) In: Berenbach, Brian (Ed.); Daneva, Maya (Ed.); Doerr, Joerg (Ed.); Fricker, Samuel (Ed.); Gervasi, Vincenzo (Ed.); Glinz, Martin (Ed.); Herrmann, Andrea (Ed.); Krams, Benedikt (Ed.); Madhavji, Nazim H. (Ed.); Paech, Barbara (Ed.); Schockert, Sixten (Ed.); Seyff, Norbert (Ed.); Universität Duisburg-Essen: 17th International Working Conference on Requirements Engineering: Foundation for Software Quality. Proceedings of the REFSQ 2011 Workshops REEV, EPICAL and RePriCo, the REFSQ 2011 Empirical Track (Empirical Live Experiment and Empirical Research Fair), and the REFSQ 2011 Doctoral Symposium. 2011, 122-127 (ICB Research Report 44)

Schneider, Daniel; Becker, Martin; Trapp, Mario: Approaching Runtime Trust Assurance in Open Adaptive Systems. (International Symposium on Software Engineering for Adaptive and Self Managing Systems <6, 2011, Waikiki>)

In: Cheng, Betty (Ed.); Giese, Holger (Ed.); Association for Computing Machinery (ACM):
 Proceeding of the 6th International Symposium on Software Engineering for Adaptive and Self-Managing Systems - SEAMS 2011
 New York : ACM Press, 2011, 196-201

Schneider, Daniel; Trapp, Mario:

A Safety Engineering Framework for Open Adaptive Systems. (International Conference on Self-Adaptive and Self-Organizing Systems <5, 2011, Michigan>)

In: IEEE Computer Society: Fifth IEEE International Conference on Self-Adaptive and Self-Organizing Systems. SASO 2011 - Proceedings
 Los Alamitos : IEEE Computer Society, 2011, 89-98

Seissler, Marc; Meixner, Gerrit; Seffah, Ahmed; Breiner, Kai; Forbrig, Peter; **Klößner, Kerstin:**

PEICS: HCI Patterns for the Design of Interactive Systems. (International Workshop on Pattern-Driven Engineering of Interactive Computing Systems <2, 2011, Pisa>)
 Proceedings of the 2nd International Workshop on Pattern-Driven Engineering of Interactive Computing Systems (PEICS'11)
 New York : ACM Press, 2011, 1-3

Seissler, Marc; Breiner, Kai; Meixner, Gerrit; Forbrig, Peter; Seffah, Ahmed; **Klößner, Kerstin:**

Pattern-Driven Engineering of Interactive Computing Systems (PEICS). (ACM SIGCHI Symposium on Engineering Interactive Computing Systems <3, 2011, Pisa>)
 EICS'11. Proceedings of the 2011 ACM SIGCHI Symposium on Engineering Interactive Computing Systems
 New York : ACM Press, 2011, 339-340

Shahbaz, Muzammil; Shashidhar, K. C.; Eschbach, Robert:

Iterative Refinement of Specification for Component Based Embedded Systems. (International Symposium on Software Testing and Analysis <2011, Toronto>)

In: Association for Computing Machinery (ACM): International Symposium on Software Testing and Analysis. ISSTA 2011 - Proceedings
 New York : ACM Press, 2011, 276-286

Villela, Karina; Cohen, Shalom; Baresi, Luciano:
 SCARVeS: Services, Clouds, and Alternative Design Strategies for Variant-Rich Software Systems. (International Software Product Line Conference <15, 2011, München>)

In: Almeida, Eduardo Santana (Ed.); Kishi, Tomoji (Ed.); Schwanninger, Christa (Ed.); **John, Isabel** (Ed.); Schmid, Klaus (Ed.): 15th International Software Product Line Conference, SPLC 2011 - Proceedings
 Los Alamitos : IEEE Computer Society, 2011, S. 342

Zimmer, Bastian; Bürklen, Susanne; Knoop, Michael; Höfflinger, Jens; **Trapp, Mario:**

Vertical Safety Interfaces - Improving the Efficiency of Modular Certification. (International Conference SAFE-COMP <30, 2011, Naples>)
 In: Flammini, Francesco (Ed.); Bologna, Sandro (Ed.); Vitorini, Valeria (Ed.): Computer Safety, Reliability, and Security. 30th International Conference. SAFECOMP 2011 - Proceedings
 Berlin : Springer-Verlag, 2011, 29-42 (Lecture Notes in Computer Science 6894)

PROCEEDINGS BY EDITORS

Wagner, Stefan (Hrsg.); Broy, Manfred (Hrsg.); Deißeböck, Florian (Hrsg.); **Liggismeyer, Peter** (Hrsg.); **Münch, Jürgen** (Hrsg.); Technische Universität München. Institut für Informatik:

Tagungsband 4. Workshop zur Software-Qualitätsmodellierung und -bewertung. SQMB' 11. (Workshop zur Software-Qualitätsmodellierung und -bewertung <4, 2011, München>)
 München, 2011

Berenbach, Brian (Ed.); Daneva, Maya (Ed.); **Doerr, Joerg** (Ed.); Fricker, Samuel (Ed.); Gervasi, Vincenzo (Ed.); Glinz, Martin (Ed.); Herrmann, Andrea (Ed.); Krams, Benedikt (Ed.); Madhavji, Nazim H. (Ed.); Paech, Barbara (Ed.); Schockert, Sixten (Ed.); Seyff, Norbert (Ed.); Universität Duisburg-Essen: 17th International Working Conference on Requirements Engineering: Foundation for Software Quality. Proceedings of the REFSQ 2011 Workshops REEW, EPICAL and RePriCo, the REFSQ 2011 Empirical Track (Empirical Live Experiment and Empirical Research Fair), and the REFSQ 2011 Doctoral Symposium. (International Working Conference on Requirements Engineering. Foundation for Software Quality <17, 2011, Essen>)
 2011 (ICB Research Report 44)

FRAUNHOFER IESE REPORTS

Adam, Sebastian; Karjalainen, Lena; Nunnenmacher, Sabine; Jung, Jessica; Olbrich, Steffen; Zimmermann, Fabian; Heintz, Matthias:
 Cloud Computing 2011 - Ziele, Bedenken und Fragestellungen hinsichtlich Softwareentwicklung. Kaiserslautern, 2011 (IESE-Report 035.11/D)

Antonino, Pablo; Schneider, Daniel; Hofmann, Cristian; Nakagawa, Elisa Yumi:
 Evaluation of AAL Platforms according to Architecture-based Quality Attributes. Kaiserslautern, 2011 (IESE-Report 069.11/E)

Armbrust, Ove; Rombach, H. Dieter:
 The Right Process For Each Context: Objective Evidence Needed. Kaiserslautern, 2011 (IESE-Report 018.11/E)

Bauer, Thomas; Eschbach, Robert:
 Testing functional requirements and interactions in distributed systems by re-using component models. Kaiserslautern, 2011 (IESE-Report 057.11/E)

Bauer, Thomas; Eschbach, Robert:
 Model-based Testing of Distributed Functions. Kaiserslautern, 2011 (IESE-Report 056.11/E)

Bauer, Thomas; Eschbach, Robert:
 Constructing Models to Enable Automated Testing of Distributed Functions in Component-based Systems. Kaiserslautern, 2011 (IESE-Report 075.11/E)

Becker, Martin; Kemmann, Sören; Shashidhar, K. C.:
 Addressing Safety in Software Product Line Engineering using Formal Methods. Kaiserslautern, 2011 (IESE-Report 073.11/E)

Duszynski, Slawomir:
 A Scalable Goal-Oriented Approach to Software Variability Recovery. Kaiserslautern, 2011 (IESE-Report 040.11/E)

Duszynski, Slawomir; Knodel, Jens; Becker, Martin:
 Analyzing the Source Code of Multiple Software Variants for Reuse Potential. Kaiserslautern, 2011 (IESE-Report 060.11/E)

Eisenbarth, Michael; Hess, Steffen; Maier, Andreas; Trapp, Marcus:
 Integrating Mobile Devices into the Car User Experience. Kaiserslautern, 2011 (IESE-Report 087.11/E)

Elberzhager, Frank; Münch, Jürgen; Rombach, H. Dieter; Freimut, Bernd:
 Optimizing cost and quality by integrating inspection and test processes. Kaiserslautern, 2011 (IESE-Report 007.11/E)

Elberzhager, Frank; Eschbach, Robert; Münch, Jürgen:
 The Relevance of Assumptions and Context Factors for the Integration of Inspections and Testing. Kaiserslautern, 2011 (IESE-Report 025.11/E)

Elberzhager, Frank; Rosbach, Alla; Münch, Jürgen; Eschbach, Robert:
 Inspection and Test Process Integration based on Explicit Test Prioritization Strategies. Kaiserslautern, 2011 (IESE-Report 092.11/E)

Elberzhager, Frank; Münch, Jürgen:
 Using Early Quality Assurance Metrics to Focus Testing Activities. Kaiserslautern, 2011 (IESE-Report 091.11/E)

Elberzhager, Frank; Münch, Jürgen; Ngoc Nha, Vi Tran:
 A Systematic Mapping Study on the Combination of Static and Dynamic Quality Assurance Techniques. Kaiserslautern, 2011 (IESE-Report 093.11/E)

Groß, Anne; Jurkiewicz, Jakub; Bom, Martin; Nawrocki, Jerzy:
 Use Cases vs. BPMN vs. EPC - Supplementing Experimental Material. Kaiserslautern, 2011 (IESE-Report 078.11/E)

Groß, Anne; Hess, Steffen:
 UX meets RE. Hohe User Experience durch bedarfsgerechte Anforderungsspezifikation. Kaiserslautern, 2011 (IESE-Report 084.11/D)

Heckemann, Karl; Gesell, Manuel; Pfister, Thomas; Berns, Karsten; Schneider, Klaus; Trapp, Mario:
 Safe Automotive Software. Kaiserslautern, 2011 (IESE-Report 066.11/E)

Hess, Steffen; Maier, Andreas; Trapp, Marcus:
 Differentiating Between Successful and Less Successful Products by Using MAInEEAC - A Model for Interaction Characterization. Kaiserslautern, 2011 (IESE-Report 054.11/E)

Hess, Steffen; Jung, Jessica:
 Measuring the Impact of iPad Usage Concerning Perceived Work Efficiency in Business Environments. Kaiserslautern, 2011 (IESE-Report 083.11/E)

Hollerith, Thorsten; Stephan, Nicole; Landmann, Dennis; Eigner, Martin; Schindler, Christian; Liggemeyer, Peter:
 Requirements and Specification Management for the Development of Mechatronic Products. Kaiserslautern, 2011 (IESE-Report 076.11/E)

Jeswein, Thomas; Riegel, Norman; Rombach, H. Dieter:
 Priorisierung von Prozessketten zwischen Wirtschaft und Verwaltung. Kaiserslautern, 2011 (IESE-Report 096.11/D)

- Jung, Christian; Rudolph, Manuel; Schwarz, Reinhard:**
Security Evaluation of Service-oriented Systems with an Extensible Knowledge Base. Kaiserslautern, 2011 (IESE-Report 038.11/E)
- Jung, Christian; Rudolph, Manuel; Schwarz, Reinhard:**
Security Evaluation of Service-Oriented Systems Using the SiSOA Method. Kaiserslautern, 2011 (IESE-Report 097.11/E)
- Kalmar, Ralf; Keuler, Thorsten; Knodel, Jens; Naab, Matthias:**
Software Architekturbewertung als effektives Mittel der Qualitätssicherung. Kaiserslautern, 2011 (IESE-Report 072.11/D)
- Kaneko, Tatsuya; Katahira, Masafumi; Miyamoto, Yuko;
Kowalczyk, Martin:
Application of GQM+Strategies@ in the Japanese Space Industry. Kaiserslautern, 2011 (IESE-Report 058.11/E)
- Kemmann, Sören; Kuhn, Thomas; Trapp, Mario:**
Extensible and Automated Model-Evaluations with INProVE. Kaiserslautern, 2011 (IESE-Report 068.11/E)
- Kemmann, Sören; Trapp, Mario:**
SAHARA - Systematic Approach for Hazard Analysis and Risk Assessment. Kaiserslautern, 2011 (IESE-Report 070.11/E)
- Kemmann, Sören; Adler, Rasmus; Trapp, Mario:**
ARID - Analysis of Risk through In-system Degradation. Kaiserslautern, 2011 (IESE-Report 071.11/E)
- Keuler, Thorsten; Knodel, Jens; Naab, Matthias:**
Architecture-Centric Software and Systems Engineering. Fraunhofer ACES: Architecture-Centric Engineering Solutions. Kaiserslautern, 2011 (IESE-Report 079.11/E)
- Kläs, Michael;** Lochmann, Klaus; Heinemann, Lars:
Evaluating a Quality Model for Software Product Assessments - A Case Study. Kaiserslautern, 2011 (IESE-Report 009.11/E)
- Kläs, Michael; Trendowicz, Adam;** Ishigai, Yasushi; Nakao, Haruka:
Handling Estimation Uncertainty with Bootstrapping: Empirical Evaluation in the Context of Hybrid Prediction Methods. Kaiserslautern, 2011 (IESE-Report 055.11/E)
- Kläs, Michael; Lampasona, Constanza; Münch, Jürgen:**
Adapting Software Quality Models: Practical Challenges, Approach, and First Empirical Results. Kaiserslautern, 2011 (IESE-Report 028.11/E)
- Kleinberger, Thomas; Jedlitschka, Andreas; Storf, Holger; Steinbach-Nordmann, Silke; Putz, Wolfgang; Groß, Anne:**
Notfallerkennung und -prävention: Ergebnisse und Verwertung. Kaiserslautern, 2011 (IESE-Report 008.11/D)
- Klößner, Kerstin; **Nass, Claudia;** Klein, Rudolf; Schmitt, Hartmut:
Positive User Experience durch natürliche Interaktion. Kaiserslautern, 2011 (IESE-Report 086.11/D)
- Kloos, Johannes; Hussain, Tanvir; Eschbach, Robert:**
Risk-based Testing of Safety-Critical Embedded Systems Driven by Fault Tree Analysis. Kaiserslautern, 2011 (IESE-Report 019.11/E)
- Kowalczyk, Martin; Armbrust, Ove;** Katahira, Masafumi; Kaneko, Tatsuya; Miyamoto, Yuko; Koishi, Yumi:
Requirements for Process Management Support: Experience from the Japanese Aerospace Industry. Kaiserslautern, 2011 (IESE-Report 024.11/E)
- Kowalczyk, Martin:**
Aligning Software Processes with Organizational Purpose using a Measurement-based Approach. Kaiserslautern, 2011 (IESE-Report 090.11/E)
- Kuhn, Thomas:**
Echtzeit auf Multicore-Systemen umsetzen. Kaiserslautern, 2011 (IESE-Report 067.11/D)
- Lampasona, Constanza; Kläs, Michael:**
Supporting the Adaptation of Software Quality Models - An Empirical Investigation. Kaiserslautern, 2011 (IESE-Report 017.11/E)
- Naab, Matthias:**
Enhancing Architecture Design Methods for Improved Flexibility in Long-Living Information Systems. Kaiserslautern, 2011 (IESE-Report 063.11/E)
- Nakagawa, Elisa Yumi; **Antonino, Pablo; Becker, Martin:**
Exploring the Use of Reference Architectures in the Development of Product Line Artifacts. Kaiserslautern, 2011 (IESE-Report 053.11/E)
- Nakagawa, Elisa Yumi; **Antonino, Pablo; Becker, Martin:**
Reference Architecture and Product Line Architecture: A Subtle But Critical Difference. Kaiserslautern, 2011 (IESE-Report 052.11/E)
- Nass, Claudia; Hess, Steffen:**
Aus die Maus - Design für natürliche Interaktion. Kaiserslautern, 2011 (IESE-Report 085.11/D)
- Riegel, Norman; Uenalan, Oezguer; Jeswein, Thomas:**
Prioritizing business process chains for IT optimization. Kaiserslautern, 2011 (IESE-Report 027.11/E)
- Schneider, Daniel; Becker, Martin; Trapp, Mario:**
Approaching Runtime Trust Assurance in Open Adaptive Systems. Kaiserslautern, 2011 (IESE-Report 022.11/E)

Schneider, Daniel; Trapp, Mario:

A Safety Engineering Framework for Open Adaptive Systems.

Kaiserslautern, 2011
(IESE-Report 065.11/E)

Shahbaz, Muzammil; Shashidhar, K. C.; Eschbach, Robert:

Iterative Refinement of Specification for Component Based Embedded Systems

Kaiserslautern, 2011
(IESE-Report 030.11/E)

Zehler, Thomas; Steffens, Petra:

Qualitätssicherung in interdisziplinären eGovernment-Projekten: Adaption bewährter Praktiken im P23R-Projekt.

Kaiserslautern, 2011
(IESE-Report 034.11/D)

Zimmer, Bastian; Bürklen, Susanne; Knoop, Michael; Höflinger, Jens; Trapp, Mario:

Vertical Safety Interfaces - Improving the Efficiency of Modular Certification.

Kaiserslautern, 2011
(IESE-Report 051.11/E)

OTHER TECHNICAL REPORTS

Diefenbach, Sarah; Klein, Bernd; **Klößner, Kerstin;** Schmitt, Hartmut; Bundesministerium für Bildung und Forschung (BMBF): Fun of use with natural interactions. Schlussbericht des Vorhabens. 2011

DOCTORAL THESES

Doerr, Joerg:

Elicitation of a Complete Set of Non-Functional Requirements.

Stuttgart: Fraunhofer Verlag, 2011
(PhD Theses in Experimental Software Engineering Vol. 34).
Zugl.: Kaiserslautern, Techn. Univ., Diss., 2010
ISBN 978-3-8396-0261-4

Keuler, Thorsten:

An Aspect-Oriented Approach for Improving Architecture Design Efficiency.

Stuttgart: Fraunhofer Verlag, 2011
(PhD Theses in Experimental Software Engineering Vol. 33).
Zugl.: Kaiserslautern, Techn. Univ., Diss., 2011
ISBN 978-3-8396-0225-6

Knodel, Jens:

Sustainable Structures in Software Implementations by Live Compliance Checking.

Stuttgart: Fraunhofer Verlag, 2011
(PhD Theses in Experimental Software Engineering Vol. 35).
Zugl.: Kaiserslautern, Techn. Univ., Diss., 2010
ISBN 978-3-8396-0233-1

Lamersdorf, Ansgar: Model-based Decision Support of Task Allocation in Global Software Development.

Stuttgart: Fraunhofer Verlag, 2011
(PhD Theses in Experimental Software Engineering Vol. 37).
Zugl.: Kaiserslautern, Techn. Univ., Diss., 2011
ISBN 978-3-8396-0305-5

Patzke, Thomas:

Sustainable Evolution of Product Line Infrastructure Code.

Stuttgart: Fraunhofer Verlag, 2011
(PhD Theses in Experimental Software Engineering Vol. 36).
Zugl.: Kaiserslautern, Techn. Univ., Diss., 2011
ISBN 978-3-8396-0315-4

MASTER'S THESES

Arango, Sandra Liliana; **Rombach, H. Dieter** (Supervisor); Abrahamsson, Pekka (Supervisor); **Lampasona, Constanza** (Supervisor): Modeling and Assessing Quality in Cloud Computing. Kaiserslautern 2011. Kaiserslautern, Techn. Univ., Master Thesis, 2011

Feth, Denis; **Rombach, H. Dieter** (Supervisor); **Pretschner, Alexander** (Supervisor): Extending Android Security with Usage Control Policies. Kaiserslautern, 2011. Kaiserslautern, Techn. Univ., Master Thesis, 2011

Moucha, Cornelius; Rombach, H. Dieter (Supervisor); **Pretschner, Alexander** (Supervisor); **Lovat, Enrico** (Supervisor):

Hypervisor-assisted Usage Control. Kaiserslautern, 2011. Kaiserslautern, Techn. Univ., Master Thesis, 2011.

Nguyen, Nga; **Silva, Adeline de Sousa** (Supervisor); Dieste, Oscar (Supervisor); **Rombach, H. Dieter** (Supervisor): Product Line Engineering and Agile Development Integra-

tion.

Kaiserslautern, 2011. Kaiserslautern, Techn. Univ., Master Thesis, 2011

Ormaetxea Badiola, Ander; **Knodel, Jens** (Supervisor); Aldekoa, Gentzane (Supervisor): Task-Oriented Documentation for Eclipse-Based Applications.

Kaiserslautern, 2011. Mondragon University, Master Thesis, 2011

Sixt, Benedikt; **Knodel, Jens** (Supervisor); **Weitzel, Balthasar** (Supervisor); Wille, Cornelius (Supervisor): Deployment Analysis of System Landscapes. Kaiserslautern, 2011. Bingen, FH, Master Thesis, 2011

Weishaar, Christoph; **Liggemeyer, Peter** (Supervisor); **Adler, Rasmus** (Supervisor); Wöhrle, Stefan (Supervisor): Entwicklung und Evaluierung einer Degradationsarchitektur für ein verteiltes Automatisierungssystem. Kaiserslautern, 2011. Kaiserslautern, Techn. Univ., Master Thesis, 2011

BACHELOR'S THESES

Goikoetxea Aurre, Asier; **Weitzel, Balthasar** (Supervisor); **Knodel, Jens** (Supervisor); Aldekoa, Gentzane (Supervisor):

Innovative Concepts to Increase User Experience for Architecture Analysis Tools. Kaiserslautern, 2011. Mondragon University, Bachelor Thesis, 2011

AWARDS

INTERNAL AWARDS

Anne Groß
The Fraunhofer IESE Award
2011 for Project Excellence

Jens Knodel
The Fraunhofer IESE Award
2011 for Project Excellence

Steffen Heß
The Fraunhofer IESE Award
2011 for Research Excellence

Jessica Jung
The Fraunhofer IESE Award
2011 for Empirical Excellence

Kai Höfig
The Fraunhofer IESE Award
2011 for Empirical Excellence

Ralf Carbon
The Fraunhofer IESE Award
2011 for Doctoral Theses
Excellence

Cornelius Moucha
The Fraunhofer IESE Award
2011 for Master Thesis Excel-
lence

Andreas Brehm
The Fraunhofer IESE Award
2011 for Infrastructure Excel-
lence

EXTERNAL AWARDS

Jörg Dörr
Auszeichnung Dissertation,
Kreissparkassen Stiftung
Kaiserslautern, Kaiserslautern
Germany, June 16, 2011

Dieter Rombach
ACM Fellows Award, Associ-
ation for Computing Machi-
nery, presented in Palo Alto,
CA, USA, June 2011

Alexander Pretschner
Best Paper Award Year
2010/2011, DFG-Schwer-
punktprogramm 1496 "Re-
liably Secure Software Sys-
tems", July 2011

APPOINTMENTS

Prof. Dr. Isabel John
Hochschule für angewandte
Wissenschaften Würzburg-
Schweinfurt (University of
Applied Sciences Würzburg-
Schweinfurt, Faculty of Com-
puter Science and Computer
Science Industry), Würzburg,
Germany, March 2011

Prof. Dr. Jürgen Münch
University of Helsinki, Faculty
of Science, Department of
Computer Science, Helsinki,
Finland, March 2011

Prof. Dr. Daniel Görlich
SRH University Heidelberg,
Faculty of Computer Science,
Heidelberg, Germany, Octo-
ber 2011

